

2016 NEW ITEM FLYER
COLLECTION



QUALITY

INNOVATION.

DESIGN.

MISSION STATEMENT

HERE AT UNITED PACIFIC, we are dedicated to providing today's drivers with innovative and exciting products that deliver exceptional performance and value. Because United Pacific's continuing success depends on our customer's satisfaction, we constantly push our designers and engineers to upgrade our facilities and processes in order to bring products of superior quality and reliability to the market. We at United Pacific promise to continue our passionate pursuit to be the first in:

QUALITY, INNOVATION AND DESIGN.

QUALITY

With over 30 years of experience in the heavy duty trucking industry, United Pacific Industries understand the rigors and stresses that our products are subjected to on the road. It is our mission to provide our customers with products of superior quality and reliability. In achieving this goal, United Pacific only partners with manufacturing facilities that conforms to our quality control requirements and standards. Our manufacturing partners meet or exceed ISO-9001 requirements. In addition, United Pacific's manufacturing partners must be equipped on site to perform the following quality assurance tests:

- AGING TEST
- AIR TIGHT TEST
- DUST TEST
- FLUX TEST
- PHOTOMETRIC TEST
- PULL FORCE TEST
- RAIN TEST
- SALT SPRAY TEST
- SHOCK TEST
- TEMPERATURE TEST
- HUMIDITY TEST
- VIBRATION TEST



United Pacific's manufacturing partners must maintain a track record of consistent quality and low product failure rate. Furthermore, our internal quality control structure allows us to function as the final quality control station prior to shipping. With the assistance of 3D computer technology, United Pacific can adhere to strict quality control standards during prototype creation and the production process. Our engineers and technicians perform a battery of tests to ensure that our products meet the demands of today's drivers and our goal to be first in quality.





ABOUT US

DESIGN

Located near some of the nation's most progressive automotive design centers, United Pacific established the UP Design Studio in 2002 to consolidate our position as the design leader in the heavy duty trucking industry. UP Design Studio utilizes the latest generation of computer aided design (CAD) and studio/graphic software. The design studio is equipped with the newest computers and rapid prototyping systems. In addition, UP Design Studio is staffed by graduates from the nation's most prestigious design colleges.

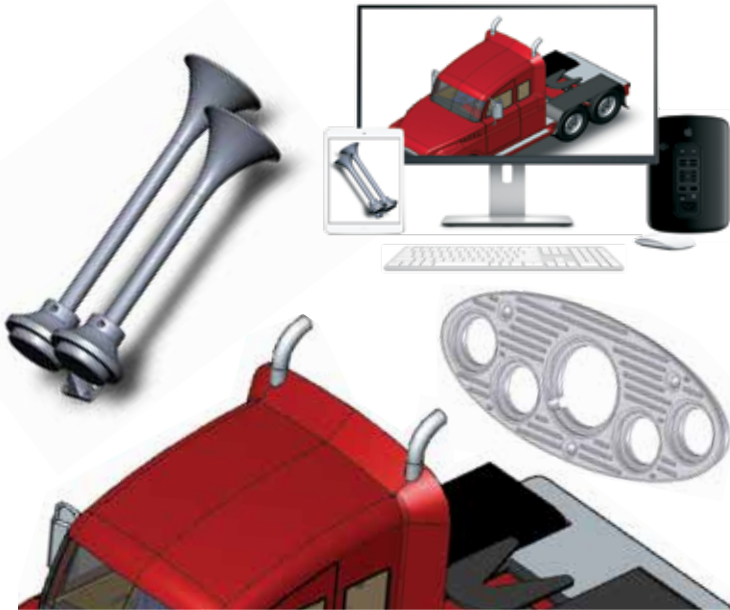

Unlike our competitors, United Pacific's design and manufacturing capabilities mean that we carry more new and original items than our competitors. The establishment of the design studio will enable us to generate even more new products with significant shorter concept-to-shelf time. The reduction in development cost mean that we can develop products utilizing design based development processes. Design based product development allows United Pacific to create new product concepts based on designs incorporating driver demands and needs instead of economic considerations. United Pacific's emphasis on design distinguishes and positions us ahead of our competitors.

HOW TO ORDER

To order from United Pacific Industries, you must be an authorized dealer, distributor or OEM.

If you are not authorized to stock and sell United Pacific products, you must order through an authorized dealer. Please call 1 (800) 790-6988 for more information.

CONTACT US

United Pacific customer service representatives are available from:

8 am - 4:30 pm PST

Toll Free: 1 (800) 790-6988

Fax: 1 (888) 986-5988

Email: sales@uapac.com

Website: www.uapac.com

INNOVATION

Known as the leader in innovation, United Pacific is dedicated to be the first to bring new and exciting products to the market. United Pacific's global expertise allows us to search the globe for new ideas and concepts. Not only do we search the globe for new products, United Pacific invest a significant amount of resources into our own research and development efforts. With the assistance of advance 3D scanning technology, our engineers and designers can acquire accurate and precise data in seconds. The 3D data allows United Pacific to verify designs, perform quality assurance tests, and reverse engineer with unprecedented speed and accuracy. Digital inspection contributes to the early detection of shape problems, provides rapid feedback on design, and eliminates unnecessary work in downstream processes. Our rapid prototyping facility permits us to have a concept-to-shelf time of less than 5 months. In addition, United Pacific's 3D printing capabilities permit our designers to have physical models of their design concepts in hours. The physical models allow our designers and marketing staff to evaluate and test the viability of different design ideas. Our rapid prototyping facility allow United Pacific to compress design cycles, improve manufacturing planning, shorten concept-to-shelf time, most importantly, generate new and innovative products.





WARRANTY

With LED (Light Emitting Diodes) rated at 100,000 hours of operation and solid-state construction, United Pacific's LED lights are extremely reliable and durable. Purchase with confidence, United Pacific offers a complete line of LED lighting products with extended warranties. Please see the warranty policy page for more details.



INVENTORY & SHIPPING

United Pacific carries over 20,000 items in our California distribution center. No other company in the heavy duty trucking industry can match United Pacific in the variety and range of in-stock inventories. With an order fill rate of over 98.5%, United Pacific is the largest and most reliable supplier in the industry. Our shipping department ships 96.8% of all orders within 24 hours and 98.9% within 48 hours. United Pacific's vast inventory and prompt shipping has made United Pacific the only source for our customer's chrome and lighting needs.



ASSEMBLED IN U.S.A.

United Pacific strives to provide today's drivers with innovative and exciting products that deliver exceptional performance and value. With our international background and expertise, we search the globe for the best and most reliable products. However, as an American company, we believe and support the American way of life. Look for the "Assembled in the USA" label on many of our products. Although the components are manufactured overseas, the products, bearing the "Assembled in the USA" labels, are hand assembled with pride in the United States.



Hard at Work for Our Customers. Hard at Work for the Environment



United Pacific
132,000 sq ft
Distribution Center
Long Beach, CA

100% reduction in potable water used for landscaping

40% reduction in total energy use due to high-efficiency mechanical and lighting systems

82% of construction waste was diverted from landfills

LEED ACCOMPLISHMENTS

Sustainable Sites

- On-site bicycle storage, showers and changing areas for company employees
- Preferred parking for low-emitting, fuel-efficient and carpool vehicles
- Stormwater is infiltrated on-site and treated to remove contaminants to reduce environmental impact on local waterways

Water Efficiency

- In addition to using reclaimed water, drought-tolerant plants and a high-efficiency irrigation system were installed to reduce the use of potable water for irrigation by 100%
- High-efficiency water closets, lavatory faucets, and showers were used to reduce annual water use by 30%

Energy and Atmosphere

- Efficient HVAC equipment and a lighting system with daylight controls reduces energy consumption by over 30%
- Enhanced commission verifies that the building's energy and water-related systems are performing as intended by the initial design

Materials and Resources

- Over 81% of construction and demolition waste was diverted from landfills

Indoor Environmental Quality

- Building ventilation system was designed to provide enhanced levels of fresh outside air to building occupants
- Interior finishes (paints, sealants, adhesives, coatings, carpet systems and composite wood) were selected with low levels of volatile organic compounds (VOCs) to reduce indoor air contamination

TABLE OF CONTENTS

2015 NEW ITEM SUPPLEMENT

JAN	JANUARY NEW ITEMS OEM LIGHTING	1 9
FEB	FEBRUARY NEW ITEMS	11
MARCH	MARCH NEW ITEMS	17
APRIL	APRIL NEW ITEMS	21
MAY	MAY NEW ITEMS	23
JUNE	JUNE NEW ITEMS	33
JULY	JULY NEW ITEMS	41
AUG	AUGUST NEW ITEMS	47
SEPT	SEPTEMBER NEW ITEMS	51
OCT	OCTOBER NEW ITEMS	59
NOV	NOVEMBER NEW ITEMS	63
DEC	DECEMBER NEW ITEMS	73
INDEX	TERMS & CONDITIONS PRODUCT INDEX	77 81



High Power 4 Row LED Light Bar - Reflector Series

Description

- 1.5W High Power LED, 4 Row LED Light Bar
- 10V - 24V Application, Reflector Illumination
- 3 1/8" Tall x 2 1/4" Wide, Light is 5 1/8" Tall with Mounting Bracket
- Available in 6 Different Lengths, Heavy Duty Aluminum Housing, **3 Years Warranty**

Item Number	LEDs	Lumens	Length	Pack
36646 (NEW)	24	2160 lm	8"	1 Pc./Box
36647 (NEW)	48	4320 lm	14"	1 Pc./Box
36648 (NEW)	80	7200 lm	22"	1 Pc./Box
36649 (NEW)	120	10800 lm	32"	1 Pc./Box
36650 (NEW)	160	14400 lm	42"	1 Pc./Box
36651 (NEW)	200	18000 lm	52"	1 Pc./Box

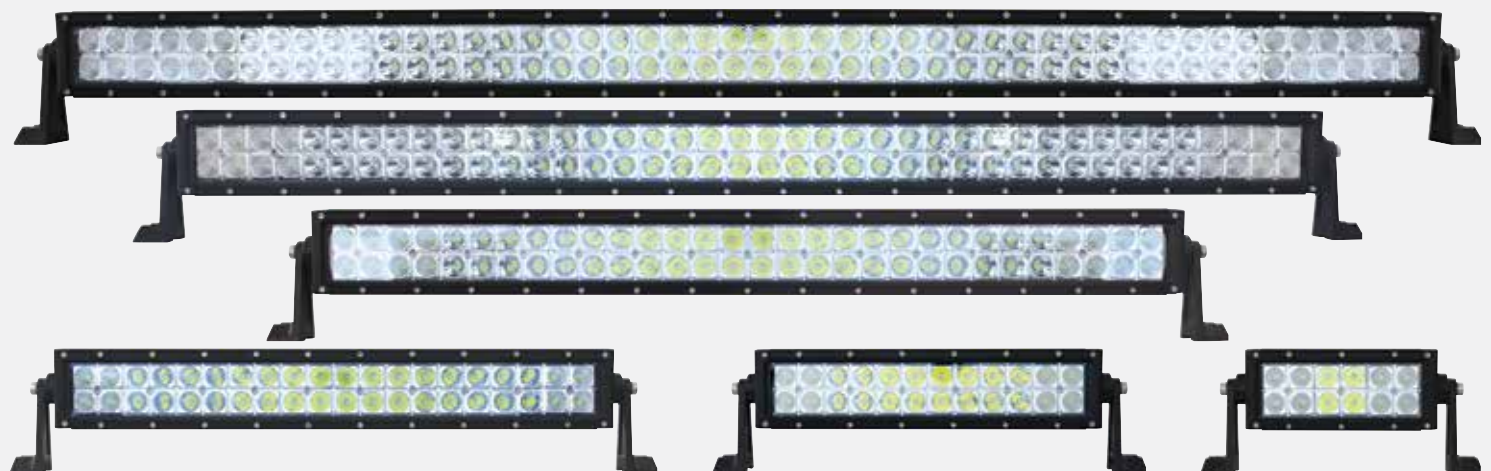
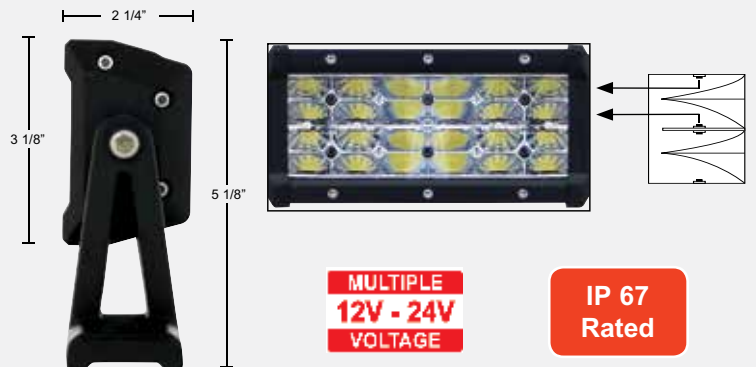

High Power Double Row LED Light Bar

Description

- 3W High Power "Cree" LED, Double Row LED Light Bar
- 12V - 24V Application
- Manufactured with USA Made "Cree" LEDs
- 3 1/8" Tall x 3 1/2" Wide, Light is 4 3/4" Tall with Mounting Bracket
- Available in 6 Different Lengths, Heavy Duty Aluminum Housing, **3 Years Warranty**

Item Number	LEDs	Lumens	Length	Pack
36781 (HOT)	12	2640 lm	7 1/2"	1 Pc./Box
36782 (HOT)	24	5280 lm	13 1/2"	1 Pc./Box
36783 (HOT)	40	8800 lm	21 1/2"	1 Pc./Box
36784 (HOT)	60	13200 lm	31 1/2"	1 Pc./Box
36785 (HOT)	80	17600 lm	41 1/2"	1 Pc./Box
36786 (HOT)	96	21120 lm	50 1/2"	1 Pc./Box

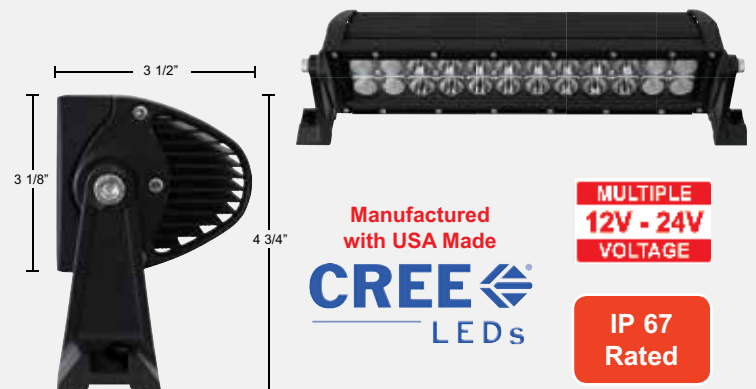

WHAT'S NEW | JAN 2016

9 LED Rectangular Cab Light for Peterbilt 579 & Kenworth T680

Description

- 9 LED Rectangular Cab Light with OEM Plug for Peterbilt 579 & Kenworth T680
- Also Fits Other Peterbilt and Kenworth Models and Years, **Lifetime Warranty**

Item Number	LEDs	Lens	Package	Pack
36779 (NEW)	9 Amber	Amber	Carded	1 Pc./Card
36780 (NEW)	9 Amber	Clear	Carded	1 Pc./Card



International Dash Switch Panel Cover

Description

- Chrome Plastic Dash Switch Panel Cover for Various International Trucks
- Easy Installation, Double Sided Tape Mount

Item Number	Description	Package	Pack
42214 (NEW)	1 Opening	Carded	1 Pc./Card
42215 (NEW)	2 Openings	Carded	1 Pc./Card
42216 (NEW)	3 Openings	Carded	1 Pc./Card
42217 (NEW)	4 Openings	Carded	1 Pc./Card
42218 (NEW)	5 Openings	Carded	1 Pc./Card
42219 (NEW)	6 Openings	Carded	1 Pc./Card



42214

42215



42216

42217



42218

42219

18" Skull Steering Wheel

Description

- 18" Wood Steering Wheel with Chrome Spokes
- Unique Skull Design, Available in White, Blue, or Red
- Steering Wheel Only, **Hub and Horn Assembly Available Separately**
- Mix and Match with United Pacific Hub and Designer Horn Bezel for a Unique and Distinctive look

Item Number	Color	Style	Package	Pack
88234 (NEW)	White	Skull	Boxed	1 Pc./Box
88235 (NEW)	Blue	Skull	Boxed	1 Pc./Box
88236 (NEW)	Red	Skull	Boxed	1 Pc./Box



88234



88235

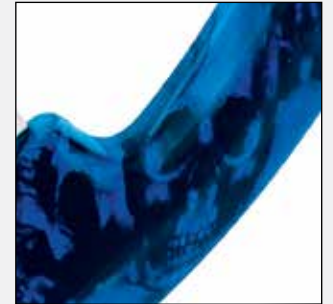

88236

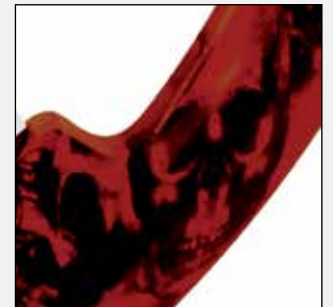

Color Retail Packaging



WHAT'S NEW | JAN 2016

2008+ Freightliner Cascadia Grill with Bug Screen

Description

- Mesh Grill with Bug Screen for 2008+ Freightliner Cascadia
- Approximately 34 1/2" L x 58" W
- Available in Chrome or Black
- **OEM Part Number: A17-16026-000**

Item Number	Finish	Fits	Package	Pack
21454 (NEW)	Black	Cascadia	Boxed	1 Pc./Box
21200 (HOT)	Chrome	Cascadia	Boxed	1 Pc./Box



2005+ Freightliner Century Grill with Bug Screen

Description

- Grill with Bug Screen for 2005+ Freightliner Century C112 and C120
- Approximately 29" L x 44 1/4" W
- Available in Chrome or Black
- **OEM Part Number: A17-16132-001**

Item Number	Finish	Fits	Package	Pack
21456 (NEW)	Black	Century	Boxed	1 Pc./Box
21191 (HOT)	Chrome	Century	Boxed	1 Pc./Box



Peterbilt Stainless Steel Grill

Description

- 430 Stainless Steel Grill for Peterbilt

- Available with Oval or 7/16" Round Cutout in Straight or Alternating Hole Patterns

Item Number	Fits	Hole Design	Hole Pattern	Pack
21061 (NEW)	Extended/ 127"	Oval	Alternating	1 Pc./Box
21062 (NEW)	Extended/ 127"	Oval	Straight	1 Pc./Box
21063 (NEW)	Extended/ 127"	Round	Alternating	1 Pc./Box
21064 (NEW)	Short Hood	Oval	Alternating	1 Pc./Box

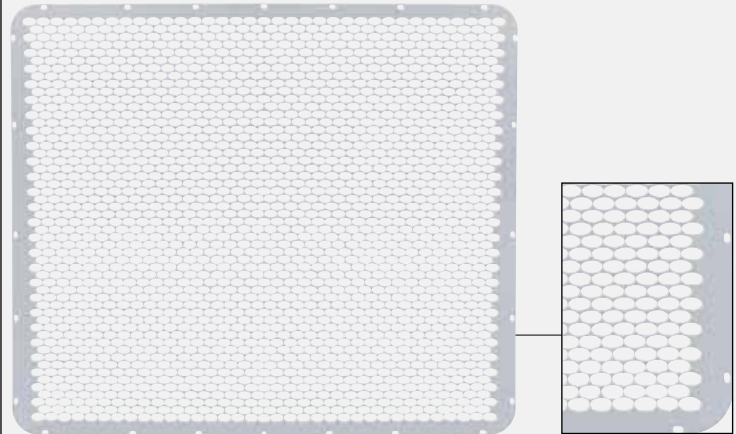

21061 Alternating Oval Hole Design

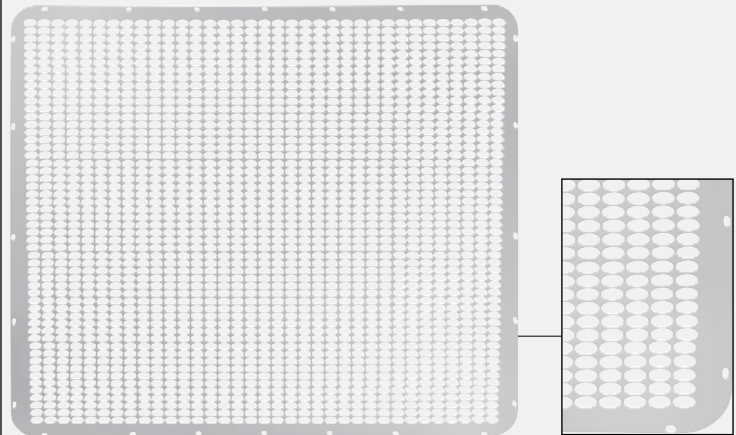

21062 Straight Oval Hole Design

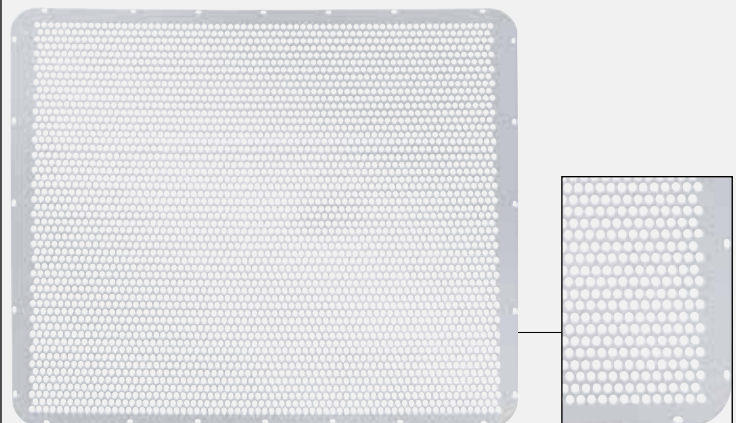

21063 Alternating Round Hole Design



WHAT'S NEW | JAN 2016

Freightliner Cascadia Exterior Door Handle

Description

- Exterior Door Handle for Freightliner Cascadia
- Sold Individually, Please Specify Driver or Passenger Side

Item Number	OEM Part Number	Application	Pack
42390B (NEW)	A18-53241-001L	Driver	1 Pc./Box
42391B (NEW)	A18-53241-001R	Passenger	1 Pc./Box



Skull Motorcycle License Frame

Description

- Chrome Die-Cast Skull Motorcycle License Frame
- Universal Design, Fits All U.S. Motorcycle License Plates

Item Number	Description	Package	Pack
50065 (NEW)	Skull License Frame	Carded	1 Pc./Card



Carbon Fiber Style Wide Bottom License Frame

Description

- Carbon Fiber Style Wide Bottom Steel License Frame
- Universal Design, Perfect for Cars, Trucks, and Pickups

Item Number	Description	Package	Pack
50079 (NEW)	Carbon Fiber Style	Carded	1 Pc./Card



Black Wide Bottom License Frame

Description

- Black Wide Bottom Steel License Frame
- Universal Design, Perfect for Cars, Trucks, and Pickups

Item Number	Description	Package	Pack
50014 (NEW)	Black	Carded	1 Pc./Card





Black "Guide" Style Hot Rod Headlight

Description

- Glossy Black Steel "Guide" Style Headlight with Chrome Rim
- Glossy Black Ready to Use, Can Also be Painted to Match Your Vehicle
- Housing Item #32018
- Sold: Boxed = 1 Each

Housing Only

Item Number	Description	Package	Pack
32018 (NEW)	Housing Only	Boxed	1 Pc./Box

Incandescent / Halogen Version

Item Number	Housing	Bulb	Bulb Type
32650 (NEW)	32018	30356	H6024 Halogen
32651 (NEW)	32018	A5023-3	H4 Halogen
32652 (NEW)	32018	31387	Crystal H4 Halogen
32653 (NEW)	32018	31378	34 LED Crystal Halogen
32654 (NEW)	32018	31379	34 LED Crystal Halogen
32655 (NEW)	32018	S2010LED	10 LED Crystal Halogen
32662 (NEW)	32018	31284	LED Halo Rim
32663 (NEW)	32018	31285	LED Halo Rim

LED Version

Item Number	Housing	Bulb	Bulb Type	LEDs
32656 (NEW)	32018	31292	Blackout LED Projection	5 High Power
32657 (NEW)	32018	31300	Chrome LED Projection	5 High Power
32658 (NEW)	32018	31353	Blackout LED	11 High Power
32659 (NEW)	32018	31355	Chrome LED	11 High Power
32660 (NEW)	32018	31289	Blackout LED	5 High Power
32661 (NEW)	32018	31391	Chrome LED	5 High Power

Bulbs



30356



A5023-3



31387



31378



31379



S2010LED



31292



31300



31353



31355



31289



31391



31284



31285

WHAT'S NEW | JAN 2016

Peterbilt Wood Armrest with LED Light

Description

- Peterbilt Wood Armrest with LED Light
- With 9" Amber, Red, or White LED in Colored or Clear Lens
- Fits 2001 and Older Peterbilt

Item Number	LED	Lens	Light	Pack
87997 (NEW)	10 White	Clear	38005B	1 Pair/Box
87992 (HOT)	10 Amber	Amber	38942B	1 Pair/Box
87993 (HOT)	10 Red	Red	38943B	1 Pair/Box
87994 (HOT)	10 Amber	Clear	38944B	1 Pair/Box
87996 (HOT)	10 Red	Clear	38945B	1 Pair/Box



87997



87992



87993



87994

United Pacific Beach Cruiser

Description

- United Pacific Beach Cruiser
- Live the California Life Style, Single Speed, Foot Break

Item Number	Description	Package	Pack
99083 (NEW)	Beach Cruiser	Boxed	1 Pc./Box



United Pacific Cap

Description

- 100% Cotton Twill Cap
- Available in 3 Different Styles

Item Number	Description	Package	Pack
99084 (NEW)	USA Flag U.P. Cap	Bulk	1 Pc.
99085 (NEW)	Flame U.P. Cap	Bulk	1 Pc.
99086 (NEW)	Camo U.P. Cap	Bulk	1 Pc.



Incandescent Tail Light - Horizontal

Description

- Incandescent Tail Light with License Light
- Black License Bracket
- Perfect for Custom Motorcycles

1928 Ford "DUO LAMP"

Item Number	Style	Rim	Housing	Pack
86800 (NEW)	28 Model "A"	Stainless	Stainless	1 Pc./Box
86801 (NEW)	28 "DUO LAMP" Blue Dot	Stainless	Stainless	1 Pc./Box
86802 (NEW)	28 "Stop" Lettering	Stainless	Stainless	1 Pc./Box
86803 (NEW)	28 Model "A"	Stainless	Black	1 Pc./Box
86804 (NEW)	28 "DUO LAMP" Blue Dot	Stainless	Black	1 Pc./Box
86805 (NEW)	28 "Stop" Lettering	Stainless	Black	1 Pc./Box
86806 (NEW)	28 Model "A"	Black	Black	1 Pc./Box
86807 (NEW)	28 "DUO LAMP" Blue Dot	Black	Black	1 Pc./Box
86808 (NEW)	28 "Stop" Lettering	Black	Black	1 Pc./Box

1932 Ford

Item Number	Style	Rim	Housing	Pack
86809 (NEW)	32 Ford	Stainless	Stainless	1 Pc./Box
86810 (NEW)	32 Ford Blue Dot	Stainless	Stainless	1 Pc./Box

1933 Ford

Item Number	Style	Rim	Housing	Pack
86811 (NEW)	33 Ford	Stainless	Stainless	1 Pc./Box
86812 (NEW)	33 Ford Blue Dot	Stainless	Stainless	1 Pc./Box
86813 (NEW)	33 Ford	Stainless	Black	1 Pc./Box
86814 (NEW)	33 Ford Blue Dot	Stainless	Black	1 Pc./Box

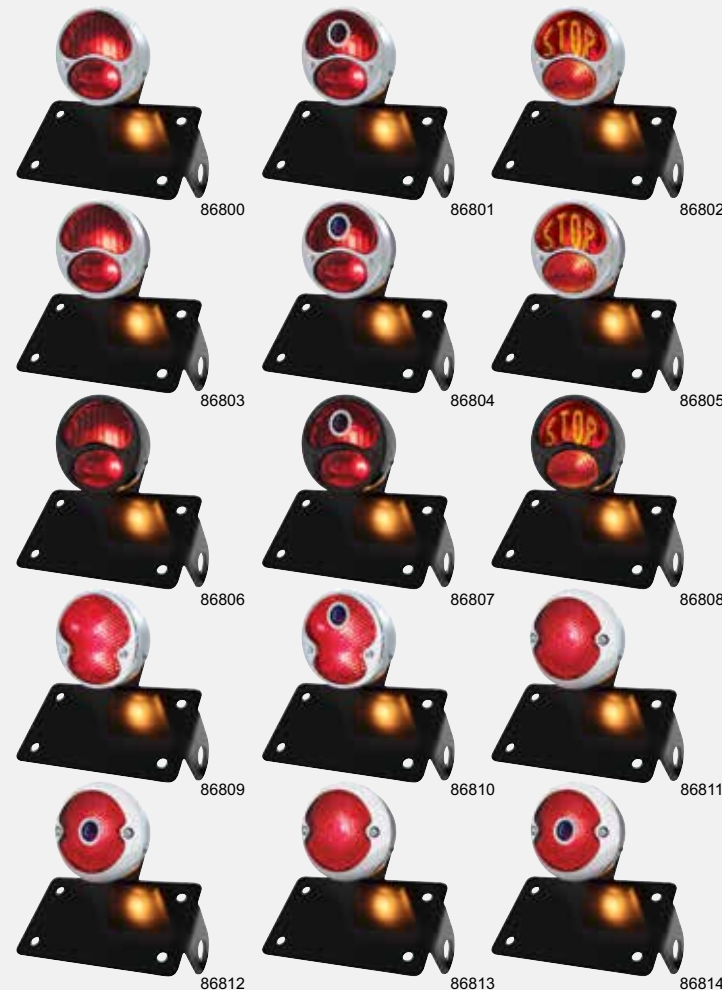

LED Tail Light - Horizontal

Description

- LED Tail Light with LED License Light
- Black License Bracket
- Perfect for Custom Motorcycles

1928 Ford "DUO LAMP"

Item Number	Style	Rim	Housing	Pack
86815 (NEW)	28 Model "A"	Stainless	Stainless	1 Pc./Box
86816 (NEW)	28 "DUO LAMP" Blue Dot	Stainless	Stainless	1 Pc./Box
86817 (NEW)	28 Model "A"	Stainless	Black	1 Pc./Box
86818 (NEW)	28 "DUO LAMP" Blue Dot	Stainless	Black	1 Pc./Box
86819 (NEW)	28 Model "A"	Black	Black	1 Pc./Box
86820 (NEW)	28 "DUO LAMP" Blue Dot	Black	Black	1 Pc./Box

1932 Ford

Item Number	Style	Rim	Housing	Pack
86821 (NEW)	32 Ford	Stainless	Stainless	1 Pc./Box

1933 Ford

Item Number	Style	Rim	Housing	Pack
86823 (NEW)	33 Ford	Stainless	Stainless	1 Pc./Box
86824 (NEW)	33 Ford	Stainless	Black	1 Pc./Box



Black "Bobber" Style Side Mount Light Bracket - Horizontal

Description

- Black "Bobber" Style Side Mount Tail light/License Bracket
- License Plate Mounts Horizontally, Custom Applications

Item Number	Description	Package	Pack
20619 (NEW)	Horizontal Mount	Boxed	1 Pc./Box



Incandescent Tail Light - Vertical

Description

- Incandescent Tail Light with License Light
- Black License Bracket
- Perfect for Custom Motorcycles

1928 Ford "DUO LAMP"

Item Number	Style	Rim	Housing	Pack
86825 (NEW)	28 Model "A"	Stainless	Stainless	1 Pc./Box
86826 (NEW)	28 "DUO LAMP" Blue Dot	Stainless	Stainless	1 Pc./Box
86827 (NEW)	28 "Stop" Lettering	Stainless	Stainless	1 Pc./Box
86828 (NEW)	28 Model "A"	Stainless	Black	1 Pc./Box
86829 (NEW)	28 "DUO LAMP" Blue Dot	Stainless	Black	1 Pc./Box
86830 (NEW)	28 "Stop" Lettering	Stainless	Black	1 Pc./Box
86831 (NEW)	28 Model "A"	Black	Black	1 Pc./Box
86832 (NEW)	28 "DUO LAMP" Blue Dot	Black	Black	1 Pc./Box
86833 (NEW)	28 "Stop" Lettering	Black	Black	1 Pc./Box

1932 Ford

Item Number	Style	Rim	Housing	Pack
86834 (NEW)	32 Ford	Stainless	Stainless	1 Pc./Box
86835 (NEW)	32 Ford Blue Dot	Stainless	Stainless	1 Pc./Box

1933 Ford

Item Number	Style	Rim	Housing	Pack
86836 (NEW)	33 Ford	Stainless	Stainless	1 Pc./Box
86837 (NEW)	33 Ford Blue Dot	Stainless	Stainless	1 Pc./Box
86838 (NEW)	33 Ford	Stainless	Black	1 Pc./Box
86839 (NEW)	33 Ford Blue Dot	Stainless	Black	1 Pc./Box



LED Tail Light - Vertical

Description

- LED Tail Light with LED License Light
- Black License Bracket
- Perfect for Custom Motorcycles

1928 Ford "DUO LAMP"

Item Number	Style	Rim	Housing	Pack
86840 (NEW)	28 Model "A"	Stainless	Stainless	1 Pc./Box
86841 (NEW)	28 "DUO LAMP" Blue Dot	Stainless	Stainless	1 Pc./Box
86842 (NEW)	28 Model "A"	Stainless	Black	1 Pc./Box
86843 (NEW)	28 "DUO LAMP" Blue Dot	Stainless	Black	1 Pc./Box
86844 (NEW)	28 Model "A"	Black	Black	1 Pc./Box
86845 (NEW)	28 "DUO LAMP" Blue Dot	Black	Black	1 Pc./Box

1932 Ford

Item Number	Style	Rim	Housing	Pack
86846 (NEW)	32 Ford	Stainless	Stainless	1 Pc./Box

1933 Ford

Item Number	Style	Rim	Housing	Pack
86848 (NEW)	33 Ford	Stainless	Stainless	1 Pc./Box
86849 (NEW)	33 Ford	Stainless	Black	1 Pc./Box



Black "Bobber" Style Side Mount Light Bracket - Vertical

Description

- Black "Bobber" Style Side Mount Tail light/License Bracket
- License Plate Mounts Vertically, Custom Applications

Item Number	Description	Package	Pack
20620 (NEW)	Vertical Mount	Boxed	1 Pc./Box



Rectangular Quick Mount Reflector

Description

- 3 1/4" x 1 9/16" Rectangular Quick Mount Reflector
- Available in Amber or Red
- Hermetically Sealed Acrylic Lens with Adhesive Backing

Item Number	Description	Package	Pack
30707 (NEW)	Amber Reflector	Bulk	1 Pc.
30708 (HOT)	Red Reflector	Bulk	1 Pc.

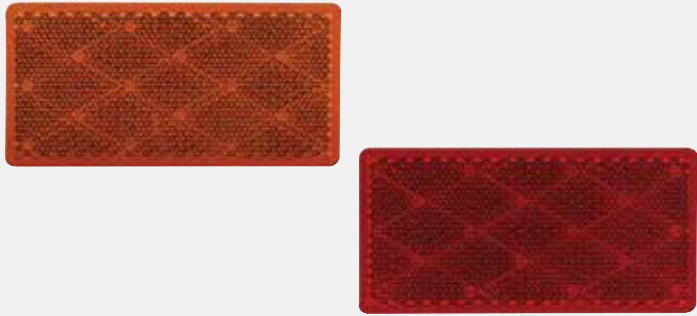

Narrow-Rail Clearance and Side Marker Light Lens

Description

- Narrow-Rail Clearance and Side Marker Light Lens
- Available in Amber or Red

Item Number	Description	Package	Pack
33081 (NEW)	Amber Lens	Bulk	1 Pc.
33082 (NEW)	Red Lens	Bulk	1 Pc.



Combination Light Lens - Red

Description

- Red Combination Light Lens

Item Number	Description	Package	Pack
33083 (NEW)	Red Lens	Bulk	1 Pc.



Rectangular Clearance and Side Marker Light Lens with Reflex

Description

- 2 3/4" x 2 1/8" Rectangular Clearance and Side Marker Light Lens
- Available in Amber or Red

Item Number	Description	Package	Pack
33080 (NEW)	Amber Lens	Bulk	1 Pc.
33084 (NEW)	Red Lens	Bulk	1 Pc.

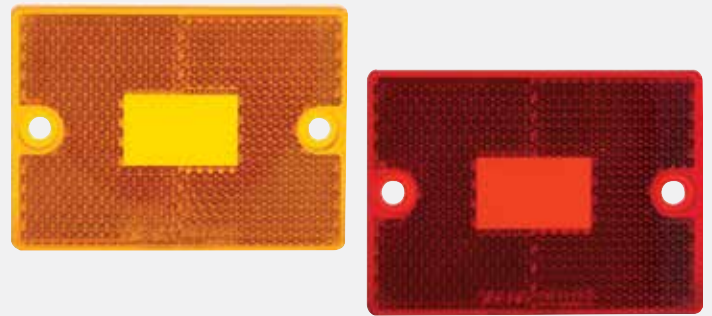

Narrow-Rail Clearance and Side Marker Light Lens

Description

- Narrow-Rail Clearance and Side Marker Light Lens
- Available in Amber or Red

Item Number	Description	Package	Pack
33085 (NEW)	Amber Lens	Bag	1 Pc.
33086 (NEW)	Red Lens	Bag	1 Pc.



Universal Stud-Mount Stop Light Lens - Red

Description

- Red Universal Stud-Mount Stop Light Lens

Item Number	Description	Package	Pack
33091 (NEW)	Red Lens	Bulk	1 Pc.



Submersible LED Combination Light Lens - Red

Description

- Red Submersible LED Combination Light Lens

Item Number	Description	Package	Pack
33088 (NEW)	Red Lens	Bulk	1 Pc.
33089 (NEW)	Side Marker Lens	Bulk	1 Pc.

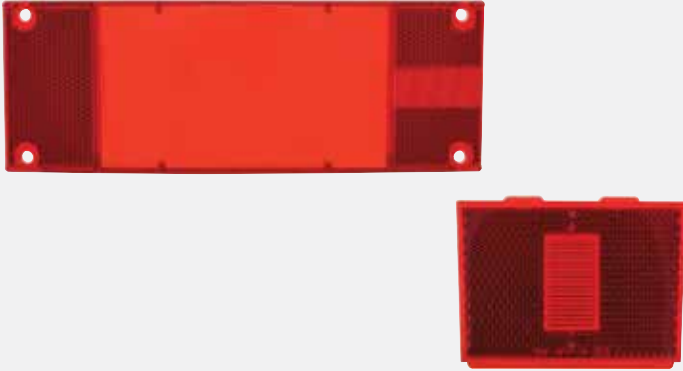

Submersible Combination Light Lens - Red

Description

- Red Submersible Combination Light Lens

Item Number	Description	Package	Pack
33090 (NEW)	Red Lens	Bulk	1 Pc.
33087 (NEW)	Side Marker Lens	Bulk	1 Pc.

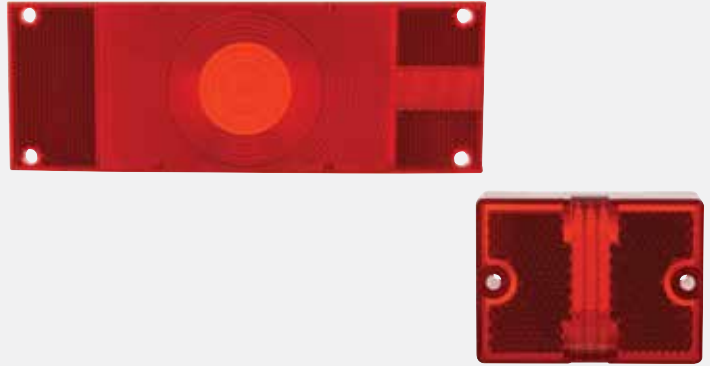

Universal Metal License Bracket

Description

- Zinc Plated Steel
- Surface Mount on 2" Centers

Item Number	Description	Package	Pack
33096 (NEW)	Metal License Bracket	Bulk	1 Pc.



Universal Plastic License Bracket

Description

- Resist Corrosion
- Flexes on Impact Molded Plastic
- Surface Mount on 2" Centers

Item Number	Description	Package	Pack
33097 (NEW)	Plastic License Bracket	Bulk	1 Pc.
33098 (NEW)	Plastic License Bracket	Bulk	1 Pc.



7 to 4-Way Harness Adapter

Description

- Converts 7-Way Round Pin Connector to 4-Way Flat Pin Connector
- Non-Corrosive Nylon Shell

Item Number	Description	Package	Pack
90628 (NEW)	7 to 4-Way Harness Adapter	Bag	1 Pc.



Trailer Harness Kit - 12" Lead Wire

Description

- Trailer Light Converter
- Flat 4-Way Male Connector

Item Number	Description	Package	Pack
90627 (NEW)	Trailer Harness Kit	Bulk	1 Pc.





“Blackout” Freightliner Columbia Projection Headlight

Description

- “Blackout” Freightliner Columbia Projection Headlight
- Fits Various 1996+ Freightliner Columbia Models
- Unique Dual LED Position Light Bar, Available in Crystal Design
- Impact Resistant Polycarbonate Lens Provide Unparalleled Protection from Road Hazards
- DOT/SAE Approved
- Sold Individually, Please Specify Driver or Passenger Side, **1 Year Warranty**

Item Number	Application	Description	Pack
31254 (NEW)	Driver	Blackout	1 Pc./Box
31255 (NEW)	Passenger	Blackout	1 Pc./Box

Technical Specifications

Low Beam Application

12V DC Input
3.9 Amps / 46.8 Watt
FMVSS 571

High Beam Application

12V DC Input
4.5 Amps / 54 Watt
FMVSS 571



BLACKOUT



Chrome Freightliner Columbia Projection Headlight

Description

- Chrome Freightliner Columbia Projection Headlight
- Fits Various 1996+ Freightliner Columbia Models
- Unique Dual LED Position Light Bar, Available in Crystal Design
- Impact Resistant Polycarbonate Lens Provide Unparalleled Protection from Road Hazards
- DOT/SAE Approved
- Sold Individually, Please Specify Driver or Passenger Side, **1 Year Warranty**

Item Number	Application	Description	Pack
31256 (HOT)	Driver	Chrome	1 Pc./Box
31257 (HOT)	Passenger	Chrome	1 Pc./Box

Technical Specifications

Low Beam Application

12V DC Input
3.9 Amps / 46.8 Watt
FMVSS 571

High Beam Application

12V DC Input
4.5 Amps / 54 Watt
FMVSS 571



HOT





High Power LED Light Bar - Stud Mount

Description

- 3W High Power LED Light Bar
- 10V - 30V Application
- 3 1/8" Tall 2 3/8" Wide, Light is 4 3/8" Tall with Mounting Bracket
- Available in 6 Different Lengths, Heavy Duty Aluminum Housing, **3 Years Warranty**

Item Number	LEDs	Lumens	Length	Pack
36634 (NEW)	6	1260 lm	4"	1 Pc./Box
36635 (NEW)	12	2520 lm	7"	1 Pc./Box
36636 (NEW)	18	3780 lm	9"	1 Pc./Box
36637 (NEW)	24	5040 lm	13"	1 Pc./Box
36638 (NEW)	30	6300 lm	18"	1 Pc./Box
36639 (NEW)	36	7560 lm	20"	1 Pc./Box

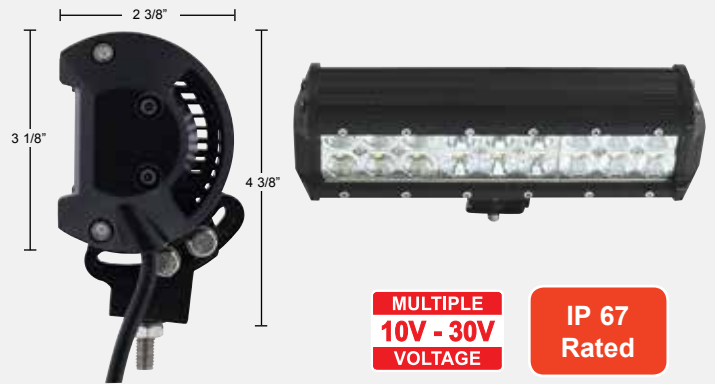

High Power LED Light Bar - Competition Series

Description

- 3W High Power LED Light Bar
- 10V - 30V Application
- 3 1/4" Tall 3 1/2" Wide, Light is 4 3/8" Tall with Mounting Bracket
- Available in 5 Different Lengths, Heavy Duty Aluminum Housing, **3 Years Warranty**

Item Number	LEDs	Lumens	Length	Pack
36640 (NEW)	12	2520 lm	10"	1 Pc./Box
36641 (NEW)	24	5040 lm	16"	1 Pc./Box
36642 (NEW)	40	8400 lm	24"	1 Pc./Box
36643 (NEW)	60	12600 lm	34"	1 Pc./Box
36644 (NEW)	80	16800 lm	44"	1 Pc./Box

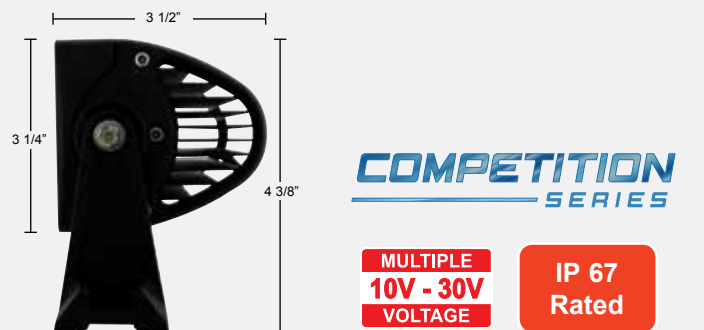

2 LED Mini Clearance/Marker Light

Description

- 2 LED Mini Clearance/Marker Light
- Requires a 3/4" Opening, 8 1/2" Wire Lead
- Available in Amber or Red LED with Colored Lens, **Lifetime Warranty**

Item Number	LEDs	Lens	Package	Pack
36849B (NEW)	2 Amber	Amber	Bulk	1 Pc.
36850B (NEW)	2 Red	Red	Bulk	1 Pc.



24 LED 12" Dual Function Light Bar - GLO Light

Description

- 24 LED 12" Dual Function Light Bar, Unique Patented "GLO" Design
- Available with Amber or Red LEDs in Colored or Clear Lens
- Approximate Size: 12" L x 5/8" W, Mounting Holes Approximately 11 7/16" Apart, **Lifetime Warranty**

Item Number	LEDs	Lens	Package	Pack
36861 (NEW)	24 Amber	Amber	Carded	1 Pc./Card
36862 (NEW)	24 Red	Red	Carded	1 Pc./Card
36863 (NEW)	24 Amber	Clear	Carded	1 Pc./Card
36864 (NEW)	24 Red	Clear	Carded	1 Pc./Card

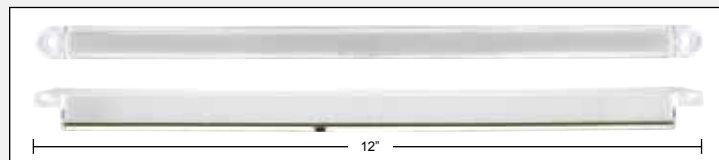

Color Retail Packaging

Dual Function

GloLight
Stand Out

3 High Power LED 1" Auxiliary/Utility Light with Visor - Dual Function

Description

- 3 High Power LED 1" Auxiliary/Utility Light with Visor
- Available in Amber or Red LED with Colored or Clear Lens, 3 Wire Hardwired

Item Number	LEDs	Lens	Package	Pack
36899 (NEW)	3 Amber	Amber	Carded	1 Pc./Card
36900 (NEW)	3 Red	Red	Carded	1 Pc./Card
36901 (NEW)	3 Amber	Clear	Carded	1 Pc./Card
36902 (NEW)	3 Red	Clear	Carded	1 Pc./Card

Dual Function



3 High Power LED 1" Clearance/Marker Light with Visor

Description

- 3 High Power LED 1" Clearance/Marker Light
- Available in Amber, Blue, Red, or White LED with Colored or Clear Lens

Item Number	LEDs	Lens	Package	Pack
36897 (NEW)	3 Amber	Amber	Carded	1 Pc./Card
36898 (NEW)	3 Red	Red	Carded	1 Pc./Card
36905 (NEW)	3 Amber	Clear	Carded	1 Pc./Card
36906 (NEW)	3 Blue	Clear	Carded	1 Pc./Card
36907 (NEW)	3 Red	Clear	Carded	1 Pc./Card
36908 (NEW)	3 White	Clear	Carded	1 Pc./Card



WHAT'S NEW | FEB 2016

3 High Power LED Mini Strobe Beacon Light

Description

- 3 High Power LED Mini Strobe Beacon Light
- 12V - 24V Application, 5 Flash Pattern
- Available in Magnet Mount or Permanent Mount
- SAE J845, Class 2 Rated

Item Number	Mount	Application	Flash Pattern
36889 (NEW)	Magnet Mount	12V - 24V	5
36890 (NEW)	Permanent Mount	12V - 24V	5



SAE J845
Class 2

2002+ International Durastar Head Lamp Extension Panel

Description

- Head Lamp Extension Panel for 2002+ International Durastar
- Sold Individually, Please Specify Driver or Passenger Side

Item Number	OEM Part Number	Application	Pack
21682 (NEW)	3545917C4	Driver	1 Pc./Box
21683 (NEW)	3545918C4	Passenger	1 Pc./Box



Freightliner Cascadia Cab Splash Guard

Description

- Cab Splash Guard for Freightliner Cascadia
- Sold Individually, Please Specify Driver or Passenger Side

Item Number	OEM Part Number	Application	Pack
20897 (NEW)	A22-69527-000	Driver	1 Pc./Box
20898 (NEW)	A22-69527-001	Passenger	1 Pc./Box



Chevy & GMC Full Size Pickup Accessory Spike Nut Cover

Description

- Fits Many 2003-15 Chevrolet & GMC Truck Models with Original Steel Wheel Hubcap
- Spike Accessory is Sized to Fit the Twist-On Simulated Lug Nut on OE Steel Wheel Hubcap
- Spike is Quality Molded Plastic with Beautiful Long Lasting Chrome Plating
- Spike Covers Sold Each. **Hubcap Not Included**

Item Number	Description	Package	Pack
10351B (NEW)	Spike Nut Cover	Bulk	1 Pc.



Shown on Late Model Chevy Pickup Hub Cap





Black "BILLET" Style Groove Headlight with Visor

Description

- Black "BILLET" Style Groove Headlight with Visor
- Available with Incandescent /Halogen Headlights or LED Headlights
- Housing Only, Item #31498, Sold: Boxed = 1 Each

Housing Only

Item Number	Description	Package	Pack
31498 (NEW)	Housing Only	Boxed	1 Pc./Box

Incandescent / Halogen Headlight

Item Number	Housing	Bulb	Bulb Type
32678 (NEW)	31498	30356	H6024 Halogen
32679 (NEW)	31498	A5023-3	H4 Halogen
32680 (NEW)	31498	31387	Crystal H4 Halogen
32681 (NEW)	31498	31378	34 Amber LED Crystal Halogen
32682 (NEW)	31498	31379	34 White LED Crystal Halogen
32683 (NEW)	31498	31284	Amber LED Halo Rim
32684 (NEW)	31498	31285	White LED Halo Rim
32685 (NEW)	31498	30354	H6014/Seal Beam

LED Headlight

Item Number	Housing	Bulb	Bulb Type
32686 (NEW)	31498	31292	Blackout 5 LED Projection
32687 (NEW)	31498	31300	Chrome 5 LED Projection
32688 (NEW)	31498	31353	Crystal Blackout 11 LED
32689 (NEW)	31498	31355	Crystal Chrome 11 LED
32690 (NEW)	31498	31289	Blackout 5 LED
32691 (NEW)	31498	31391	Chrome 5 LED

Incandescent / Halogen Headlight Bulbs



30354



30356



A5023-3



31387



31378



31379



31284



31285

LED Headlight Bulbs



31292



31300



31353



31355



31289



31391



Black "BILLET" Style Groove Headlight

Description

- Black "BILLET" Style Groove Headlight
- Available with Incandescent /Halogen Headlights or LED Headlights
- Housing Only, Item #31497, Sold: Boxed = 1 Each

Housing Only

Item Number	Description	Package	Pack
31497 (NEW)	Housing Only	Boxed	1 Pc./Box

Incandescent / Halogen Headlight

Item Number	Housing	Bulb	Bulb Type
32664 (NEW)	31497	30356	H6024 Halogen
32665 (NEW)	31497	A5023-3	H4 Halogen
32666 (NEW)	31497	31387	Crystal H4 Halogen
32667 (NEW)	31497	31378	34 Amber LED Crystal Halogen
32668 (NEW)	31497	31379	34 White LED Crystal Halogen
32669 (NEW)	31497	31284	Amber LED Halo Rim
32670 (NEW)	31497	31285	White LED Halo Rim
32671 (NEW)	31497	30354	H6014/Seal Beam

LED Headlight

Item Number	Housing	Bulb	Bulb Type
32672 (NEW)	31497	31292	Blackout 5 LED Projection
32673 (NEW)	31497	31300	Chrome 5 LED Projection
32674 (NEW)	31497	31353	Crystal Blackout 11 LED
32675 (NEW)	31497	31355	Crystal Chrome 11 LED
32676 (NEW)	31497	31289	Blackout 5 LED
32677 (NEW)	31497	31391	Chrome 5 LED

Incandescent / Halogen Headlight Bulbs



LED Headlight Bulbs



March 2016

WHAT'S NEW



HIGH POWER LED LIGHT BAR - CURVED

- 3W High Power Double Row, Curved LED Light Bar
- 10V - 30V Application, IP 67 Rated
- 3" Tall 3 7/8" Wide, Light is 4 3/4" Tall with Mounting Bracket
- Available in 6 Different Lengths, Heavy Duty Aluminum Housing, **3 Years Warranty**

ITEM NUMBER	LEDs	LUMENS	LENGTH	PACK
36763 (NEW)	12	2160 lm	8"	1 Pc./Box
36764 (NEW)	24	4320 lm	14"	1 Pc./Box
36765 (NEW)	40	7200 lm	24"	1 Pc./Box
36766 (NEW)	60	10800 lm	32"	1 Pc./Box
36767 (NEW)	80	14400 lm	42"	1 Pc./Box
36768 (NEW)	96	17280 lm	50"	1 Pc./Box



3 HIGH POWER LED BEACON LIGHT

- 3 High Power LED Beacon Light
- 12V - 24V Application, 5 Flash Pattern
- Available in Magnet or Permanent Mount
- SAE B17, Class 2 Rated

**SAE B17
Class 2**

ITEM NUMBER	MOUNT	APPLICATION	FLASH PATTERN
36537 (NEW)	Magnet	12V-24V	5
36538 (NEW)	Permanent	12V-24V	5



3 HIGH POWER LED BEACON LIGHT

- 3 High Power LED Beacon Light
- 12V - 24V Application, 5 Flash Pattern
- Available in Magnet or Permanent Mount
- SAE B15, Class 2 Rated

**SAE B15
Class 2**

ITEM NUMBER	MOUNT	APPLICATION	FLASH PATTERN
36539 (NEW)	Magnet	12V-24V	5
36540 (NEW)	Permanent	12V-24V	5



90800



90801



Double J Hook



90802



90803

NEW!

RATCHET TIE DOWN

- Heavy Duty Ratchet Tie Down
- Zinc Plated Double J Hook
- Rubberized Cover Handle for Added Comfort and Grip
Item #: 90800 and 90801

ITEM NUMBER	DESCRIPTION	BREAK STRENGTH	LOAD LIMITS	PACK
90800 (NEW)	1.5" x 15" Tie Down	6600 lbs.	2200 lbs.	1 Pc./ Retail Pack
90801 (NEW)	2" x 27" Tie Down	10000 lbs.	3333 lbs.	1 Pc./ Retail Pack
90802 (NEW)	3" x 27" Tie Down	15000 lbs.	5000 lbs.	1 Pc./ Bulk
90803 (NEW)	4" x 30" Tie Down	16200 lbs.	5400 lbs.	1 Pc./ Bulk

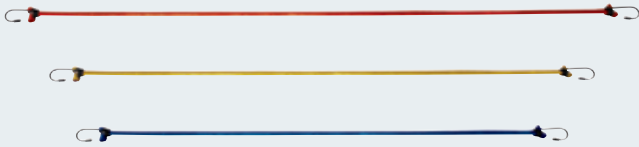

Color Retail Packaging

BUNGEE CORD SET WITH COATED STEEL HOOK

- (2) 18", (2) 24" and (2) 30" Bungee Cord with Coated Steel Hook

ITEM NUMBER	DESCRIPTION	PACKAGE	PACK
90804 (NEW)	Bungee Cord	Jar	6Pcs./Jar



90805

Color Retail Packaging



90806



90807

NEW!

EPDM RUBBER TARP STRAP

- Premium Quality EPDM Rubber Tarp Strap, 2 Pack
- Compounded EPDM Rubber Strap Will Not Crack, Rot or Lose Rebound Qualities
- Corrosion, Sunlight, and Weather Resistant
- Zinc Plated, Strong Steel Hooks Will Not Bend, Break or Rust
- Low Temperature Resistant, Non-Brittle to -40F

ITEM NUMBER	DESCRIPTION	PACKAGE	PACK
90805 (NEW)	15" EPDM Rubber Strap	Carded	2Pcs./Card
90806 (NEW)	21" EPDM Rubber Strap	Carded	2Pcs./Card
90807 (NEW)	31" EPDM Rubber Strap	Carded	2Pcs./Card



COMPETITION SERIES

4 TRUMPET CHROME HORN COMPETITION SERIES

- Chrome 4 Trumpet Train Horn, Competition Series, Super Loud
- Sound Output: 124 db (+-) 10 db
- 12V Heavy Duty Electric Solenoid Included
- 150 PSI MAX

Color Retail Packaging

ITEM NUMBER	DESCRIPTION	PACKAGE	PACK
46152 (NEW)	4 Trumpet Train Horn	Boxed	1 Pc./Box



NEW!

36545 36550

HIGH POWER 2 WATT X 2 LED **LIGHT 250 LUMENS**

2 HIGH POWER LED 3156 / 3157 BULB

- 2 High Power 2 Watt LEDs, Super Bright, 250 Lumens
- Available in Red and White, 3156 and 3157 Wedge Base

ITEM NUMBER	LEDs	BULB TYPE	LUMENS	PACK
36545 (NEW)	2 Red	3156	250 lm	1 Pc./Card
36546 (NEW)	2 White	3156	250 lm	1 Pc./Card
36549 (NEW)	2 Red	3157	250 lm	1 Pc./Card
36550 (NEW)	2 White	3157	250 lm	1 Pc./Card

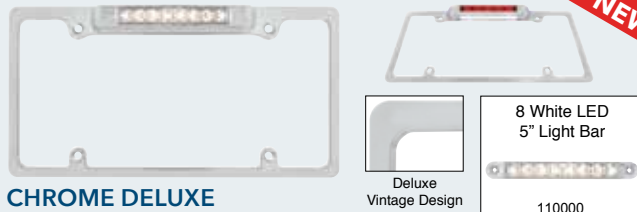

NEW!

CHROME DELUXE LED LICENSE PLATE FRAME

- Beautiful Chrome Die Cast Art-Dec Design Light Housing & Frame
- White LED License Plate Light with 11 LED
- Rear Facing Light Available in Red, White, and Amber

Deluxe Vintage Design 8 White LED 5" Light Bar 110000

ITEM NUMBER	LEDs	FUNCTION	PACKAGE	PACK
50187 (NEW)	8 White	Back-up	Carded	1 Pc./Card
50148 (HOT)	5 Red	3rd Brake	Carded	1 Pc./Card
50149 (HOT)	5 Amber	Aux.	Carded	1 Pc./Card



NEW!

CHROME INTERIOR SLEEPER DOOR HANDLE TRIM

- Fits Various Peterbilt and Kenworth Models
- Easy Installation, Snap-In

ITEM NUMBER	DESCRIPTION	PACKAGE	PACK
41744 (NEW)	Sleeper Door Handle Trim	Carded	1 Pc./Card



NEW!

1987-93 FORD MUSTANG TAIL LIGHT LENS ASSEMBLY

- Tail Light Lens Assembly for 1987-93 Fox Body Ford Mustang
- Complete Lens with Housing
- Sold Individually, Please Specify Driver Side or Passenger Side

ITEM NUMBER	DESCRIPTION	PACKAGE	PACK
110135 (NEW)	Driver/Left Hand	Boxed	1 Pc./Box
110136 (NEW)	Passenger/Right Hand	Boxed	1 Pc./Box



NEW!



**CHROME
"SLOT" 13/18 SPEED SHIFT KNOB**

- Chrome "Slot" Pistol Grip Shift Knob
- Fits 13/18 Speed Gearshift Knobs, Machined Grip
- Mounting Adapter: Item # 70603B and "Slot" Pistol Grip Knob: Item # 70659 Available Separately
- "Patent Pending"

ITEM NUMBER	STYLE	FINISH	PACKAGE	PACK
70684 (NEW)	Pistol	Chrome	Boxed	1 Pc./Box

NEW!



**CHROME
"GATLING" 13/18 SPEED SHIFT KNOB**

- Chrome "Gatling" Pistol Grip Shift Knob
- Fits 13/18 Speed Gearshift Knobs, Machined Grip
- Mounting Adapter: Item # 70603B and "Gatling" Pistol Grip Knob: Item # 70651 Available Separately
- "Patent Pending"

ITEM NUMBER	STYLE	FINISH	PACKAGE	PACK
70683 (NEW)	Pistol	Chrome	Boxed	1 Pc./Box

NEW!



**CHROME
"SLOT" PISTOL GRIP SHIFT KNOB**

- Chrome "Slot" Pistol Grip Shift Knob
- Ultra High Quality Chrome Finish, Machined Grip
- Universal Hex Screw Mount Design, Includes Mounting Hardware

ITEM NUMBER	STYLE	FINISH	PACKAGE	PACK
70659 (NEW)	Pistol	Chrome	Carded	1 Pc./Card

NEW!



**CHROME
"GATLING" PISTOL GRIP SHIFT KNOB**

- Chrome "Gatling" Pistol Grip Shift Knob
- Ultra High Quality Chrome Finish, Machined Grip
- Universal Hex Screw Mount Design, Includes Mounting Hardware

ITEM NUMBER	STYLE	FINISH	PACKAGE	PACK
70651 (NEW)	Pistol	Chrome	Carded	1 Pc./Card

UN160225

APRIL 2016 WHAT'S NEW



Freightliner Century
Headlight Bezel Sold Separately
Item # 32198/32199



FREIGHTLINER 22 LED TURN SIGNAL WITH CHROME REFLECTOR

- 22 Amber LED Freightliner Turn Signal Light with Chrome Reflector
- Available with Amber or Clear Lens, 3 Wire Hardwired
- Fits Freightliner Century and Various Freightliner Truck Models

ITEM NUMBER	LEDs	LENS	PACKAGE	PACK
36769 (NEW)	22	Amber	Carded	1 Pc./Card
36770 (NEW)	22	Clear	Carded	1 Pc./Card

NEW!

**2 HIGH POWER LED
3156 BULB**

- 3156 Bulb with 2 High Power 2 Watt LEDs, Super Bright
- Available in Amber, Red and White, 3156 Wedge Base

ITEM NUMBER	LEDs	BULB TYPE	LUMENS	PACK
36543 (NEW)	2 Amber	3156	250 lm	1 Pc./Card
36545 (HOT)	2 Red	3156	250 lm	1 Pc./Card
36546 (HOT)	2 White	3156	250 lm	1 Pc./Card

NEW!

**2 HIGH POWER LED
3157 BULB**

- 3157 Bulb with 2 High Power 2 Watt LEDs, Super Bright
- Available in Amber, Red and White, 3157 Wedge Base

ITEM NUMBER	LEDs	BULB TYPE	LUMENS	PACK
36547 (NEW)	2 Amber	3157	250 lm	1 Pc./Card
36549 (HOT)	2 Red	3157	250 lm	1 Pc./Card
36550 (HOT)	2 White	3157	250 lm	1 Pc./Card



NEW!



1986+ PETERBILT 378/379 STAINLESS FENDER GUARD

- Stainless Steel Fender Guard for 1986+ Peterbilt 378/379
- 18 Gauge, 304 Stainless
- Includes Mounting Hardware
- Some Drilling Maybe Required for Installation
- Sold in Pairs

ITEM NUMBER	DESCRIPTION	PACKAGE	PACK
20572 (NEW)	Fender Guard	Boxed	1 Pair/Box



NEW!



1986+ PETERBILT 378/379 STAINLESS FENDER GUARD WITH HEADLIGHT MOUNT

- Stainless Steel Fender Guard with Headlight Mount for 1986+ Peterbilt 378/379
- 18 Gauge, 304 Stainless
- Includes Mounting Hardware
- Some Drilling Maybe Required for Installation
- Sold in Pairs

ITEM NUMBER	DESCRIPTION	PACKAGE	PACK
20584 (NEW)	Fender Guard with Headlight Mount	Boxed	1 Pair/Box



NEW!

CHROME FLUSH MOUNT LED LICENSE PLATE LIGHT

- Beautiful Chrome Die Cast Art-Deco Design Light Housing
- White LED License Plate Light with 11 LED
- Rear Facing Light Available in Red or White
- Includes Mounting Pad with Lip and Mounting Hardware

ITEM NUMBER	LEDs	FUNCTION	PACKAGE	PACK
110203 (NEW)	5 Red	3rd Brake	Carded	1 Pc./Card
110204 (NEW)	8 White	Back-Up	Carded	1 Pc./Card



NEW!

LED MOTORCYCLE LICENSE PLATE FRAME

- Chrome Die Cast Motorcycle License Plate Frame with 5 LED Third Brake Light and 11 LED License Light
- Third Brake Light Also has Running Light Function
- White LED License Plate Light with 11 Red LED License Light

ITEM NUMBER	DESCRIPTION	PACKAGE	PACK
110205 (NEW)	Red LED License Frame	Carded	1 Pc./Card

Deluxe Vintage Design

UN160325

MAY 2016

WHAT'S NEW



**304
Stainless**

STAINLESS PETERBILT 359 LED HEADLIGHT

- 304 Stainless Steel Peterbilt 359 Style LED Headlight
- Light Weight & Less Maintenance than Aluminum Housing
- Give your Truck the Classic 359 Look
- Includes 5 3/4" LED Headlight with LED Position Light Bar: Item # 31267



**Color Retail
Packaging**



White LED Position Light Bar

ITEM #	APPLICATION	PACKAGE	PACK
32143	Driver / Left	Boxed	1 Pc./Box
32144	Passenger / Right	Boxed	1 Pc./Box

NEW!

5 3/4" LED HEADLIGHT WITH LED POSITION LIGHT BAR

- 9 High Power LED Headlight with LED Position Light Bar
- Reinforced Aluminum Reflector, Rugged Anti-Vibration Construction
- DOT/SAE: HL P 15

ITEM #	DESCRIPTION	PACKAGE	PACK
31267	5 3/4" LED Headlight Bulb	Boxed	1 Pc./Box

NEW!

KENWORTH T660 SERIES FOG LIGHT

- Fog Light for Kenworth T660 Series
- OEM Fit, Plug into Existing Wiring Harness

ITEM #	DESCRIPTION	OEM #	PACK
31234	Kenworth T660 Fog Light	P54-1062-100	1 Pc./Box



NEW!

12 HIGH POWER LED SUPER THIN WARNING LIGHT

- 12 High Power LED Super Thin Directional Warning Light
- 12V - 24V Application, 4 Wires Hardwired, Only 3/8" Tall
- 25 Flash Pattern, 2 Groups in Short (Single or Double) Flashes
- Surface Mount, Mounting Holes are 4 1/16" Apart
- Approximate Size: 4 1/2" L x 1 3/4" W x 3/8" H

ITEM #	LEDS	APPLICATION	FLASH PATTERN	PACK
36845B	12 Amber	12V - 24V	25	1 Pc./Box
36846B	6 Amber /6 White	12V - 24V	25	1 Pc./Box

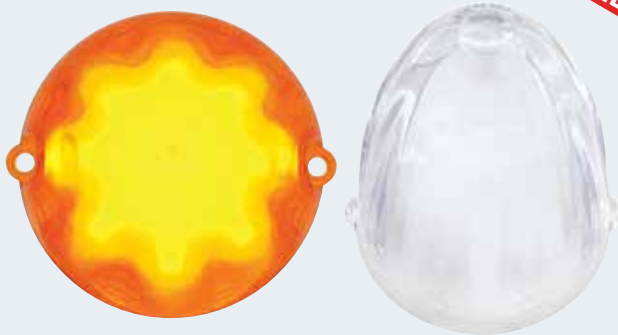

NEW!

Dual Function

9 LED DUAL FUNCTION

"GLO" WATERMELON GRAKON 1000 LIGHT

- 9 LED "GLO" Watermelon Cab/Auxiliary Light for Grakon 1000, Fits Grakon 1000 Cab Light
- Unique Patent Pending "GLO" Design
- Hard Wired with Three .180 Bullet Plugs, **Lifetime Warranty**

GloLight.

ITEM #	LEDS	LENS	PACKAGE	PACK
36662	9 Amber	Amber	Carded	1 Pc./Card
36662B	9 Amber	Amber	Bulk	1 Pc.
36663	9 Amber	Clear	Carded	1 Pc./Card
36663B	9 Amber	Clear	Bulk	1 Pc.



NEW!

Dual Function

GloLight.

9 LED DUAL FUNCTION

"GLO" WATERMELON LIGHT

- 9 LED Dual Function "GLO" Cab/Auxiliary Light with Watermelon Lens
- Unique Patent Pending "GLO" Design
- Fully Sealed, Fits Existing Light Housing
- Hard Wired with Three .180 Bullet Plugs, **Lifetime Warranty**

ITEM #	LEDS	LENS	PACKAGE	PACK
36658	9 Amber	Amber	Carded	1 Pc./Card
36658B	9 Amber	Amber	Bulk	1 Pc.
36659	9 Red	Red	Carded	1 Pc./Card
36659B	9 Red	Red	Bulk	1 Pc.
36660	9 Amber	Clear	Carded	1 Pc./Card
36660B	9 Amber	Clear	Bulk	1 Pc.
36661	9 Red	Clear	Carded	1 Pc./Card
36661B	9 Red	Clear	Bulk	1 Pc.



GloLight. **Dual Function**

9 LED DUAL FUNCTION "GLO" WATERMELON CAB LIGHT KIT

- Available in Amber or Clear Lens with Watermelon Lens
- Chrome Plastic Housing Available Separately, Item # 30496
- Hard Wired with Three .180 Bullet Plugs

ITEM #	LEDS	LENS	PACKAGE	PACK
36761	9 Amber	Amber	Boxed	1 Kit/Box
36762	9 Amber	Clear	Boxed	1 Kit/Box



GloLight. **Dual Function**

9 LED DUAL FUNCTION STAINLESS "GLO" LIGHT BRACKET

- Available in Amber, Red or Clear Lens with Watermelon Lens
- Stainless Steel Light Bracket Available Separately, Item # 20461
- Chrome Plastic Visor Available Separately, Item # 39211B

ITEM #	LEDS	LENS	VISOR	PACK
34412	9 Amber	Amber	Yes	Bulk = 1 Pc.
34413	9 Red	Red	Yes	Bulk = 1 Pc.
34414	9 Amber	Clear	Yes	Bulk = 1 Pc.
34415	9 Red	Clear	Yes	Bulk = 1 Pc.
34416	9 Amber	Amber	No	Bulk = 1 Pc.
34417	9 Red	Red	No	Bulk = 1 Pc.
34418	9 Amber	Clear	No	Bulk = 1 Pc.
34419	9 Red	Clear	No	Bulk = 1 Pc.



GloLight. **Dual Function**

9 LED DUAL FUNCTION "GLO" WATERMELON LIGHT - FLUSH MOUNT

- Available in Amber, Red or Clear Lens with Watermelon Lens
- Stainless Steel Bezel Available Separately, Item # 30317B
- Chrome Plastic Visor Available Separately, Item # 39211B

ITEM #	LEDS	LENS	VISOR	PACK
34404	9 Amber	Amber	Yes	Bulk = 1 Pc.
34405	9 Red	Red	Yes	Bulk = 1 Pc.
34406	9 Amber	Clear	Yes	Bulk = 1 Pc.
34407	9 Red	Clear	Yes	Bulk = 1 Pc.
34408	9 Amber	Amber	No	Bulk = 1 Pc.
34409	9 Red	Red	No	Bulk = 1 Pc.
34410	9 Amber	Clear	No	Bulk = 1 Pc.
34411	9 Red	Clear	No	Bulk = 1 Pc.



GloLight. **Dual Function**

TWO 9 LED DUAL FUNCTION STAINLESS "GLO" LIGHT BRACKET

- Available in Amber, Red or Clear Lens with Watermelon Lens
- Stainless Steel Light Bracket Available Separately, Item # 20751
- Chrome Plastic Visor Available Separately, Item # 39211B

ITEM #	LEDS	LENS	VISOR	PACK
34420	9 Amber	Amber	Yes	Bulk = 1 Pc.
34421	9 Red	Red	Yes	Bulk = 1 Pc.
34422	9 Amber	Clear	Yes	Bulk = 1 Pc.
34423	9 Red	Clear	Yes	Bulk = 1 Pc.
34424	9 Amber	Amber	No	Bulk = 1 Pc.
34425	9 Red	Red	No	Bulk = 1 Pc.
34426	9 Amber	Clear	No	Bulk = 1 Pc.
34427	9 Red	Clear	No	Bulk = 1 Pc.



GloLight™ **Dual Function**

9 LED DUAL FUNCTION DOUBLE FACE "GLO" LIGHT

- Available in Amber, Red or Clear Lens with Watermelon Lens
- Chrome Housing Available Separately, Item # 39544B
- Single Stud Mounting, Hard Wired with Three .180 Bullet Plugs

ITEM #	LEDS	LENS	PACKAGE	PACK
34428	9 Amber 9 Red	Amber Red	Bulk	1 Pc.
34429	9 Amber 9 Red	Clear Clear	Bulk	1 Pc.



GloLight™ **Dual Function**

9 LED DUAL FUNCTION SINGLE FACE "GLO" LIGHT

- Available in Amber, Red or Clear Lens with Watermelon Lens
- Chrome Housing Available Separately, Item # 30929
- Single Stud Mounting, Hard Wired with Three .180 Bullet Plugs

ITEM #	LEDS	LENS	PACKAGE	PACK
34430	9 Amber	Amber	Bulk	1 Pc.
34431	9 Red	Red	Bulk	1 Pc.
34432	9 Amber	Clear	Bulk	1 Pc.
34433	9 Red	Clear	Bulk	1 Pc.



GloLight™ **Dual Function**

PETERBILT "GLO" LED FRONT AIR CLEANER BRACKET

- Stainless Peterbilt Front Air Cleaner Bracket with Eight 9 "GLO" LED Watermelon Auxiliary Lights
- Stainless Steel Bezel Available Separately, Item # 30317
- Chrome Plastic Bezel with Visor Available Separately, Item # 39211B

ITEM # W/SS BEZEL	ITEM # W/CR VISOR	LEDS	LENS	PACK
34434	34436	9 Amber x 8	Amber	Bulk = 1 Pair
34435	34437	9 Amber x 8	Clear	Bulk = 1 Pair



GloLight.

Dual Function

PPETERBILT

"GLO" LED FRONT AIR CLEANER BRACKET

- Stainless Peterbilt Front Air Cleaner Bracket with Twelve 9 "GLO" LED Watermelon Auxiliary Lights
- Stainless Steel Bezel Available Separately, Item # 30317
- Chrome Plastic Bezel with Visor Available Separately, Item # 39211B

ITEM # W/SS BEZEL	ITEM # W/CRVISOR	LEDS	LENS	PACK
34438	34440	9 Amber x 12	Amber	Bulk = 1 Pair
34439	34441	9 Amber x 12	Clear	Bulk = 1 Pair



9 LED DUAL FUNCTION "GLO" WATERMELON GRAKON 1000 CAB LIGHT KIT

- Available in Amber or Clear Lens in Watermelon Lens
- Chrome Plastic Housing Available Separately, Item # 30606B
- Chrome Plastic Housing with Visor Available Separately, Item # 30605B

ITEM #	LEDS	LENS	VISOR	PACK
36757	9 Amber	Amber	Yes	1 Kit/Card
36758	9 Amber	Clear	Yes	1 Kit/Card
36759	9 Amber	Amber	No	1 Kit/Card
36760	9 Amber	Clear	No	1 Kit/Card



GloLight.

Dual Function

9 LED DUAL FUNCTION "GLO" WATERMELON LIGHT - FLUSH MOUNT

- Available with Amber or Clear Lens in Watermelon Lens
- Chrome Plastic Bezel Available Separately, Item # 39209B
- Chrome Plastic Bezel with Visor Available Separately, Item # 39208B
- Hard Wired with Three .180 Bullet Plugs

ITEM #	LEDS	LENS	VISOR	PACK
34442	9 Amber	Amber	Yes	Bulk = 1 Pc.
34443	9 Amber	Clear	Yes	Bulk = 1 Pc.
34444	9 Amber	Amber	No	Bulk = 1 Pc.
34445	9 Amber	Clear	No	Bulk = 1 Pc.



GloLight™

Dual Function

9 LED DUAL FUNCTION STAINLESS "GLO" LIGHT BRACKET

- Available in Amber or Clear Lens with Watermelon Lens
- Stainless Light Bracket Available Separately, Item # 20461
- Hard Wired with Three .180 Bullet Plugs

ITEM #	LEDS	LENS	VISOR	PACK
34446	9 Amber	Amber	Yes	Bulk = 1 Pc.
34447	9 Amber	Clear	Yes	Bulk = 1 Pc.
34448	9 Amber	Amber	No	Bulk = 1 Pc.
34449	9 Amber	Clear	No	Bulk = 1 Pc.



GloLight™

Dual Function

TWO 9 LED DUAL FUNCTION STAINLESS "GLO" LIGHT BRACKET

- Available in Amber or Clear Lens with Watermelon Lens
- Stainless Light Bracket Available Separately, Item # 20751
- Hard Wired with Three .180 Bullet Plugs

ITEM #	LEDS	LENS	VISOR	PACK
34450	9 Amber	Amber	Yes	Bulk = 1 Pc.
34451	9 Amber	Clear	Yes	Bulk = 1 Pc.
34452	9 Amber	Amber	No	Bulk = 1 Pc.
34453	9 Amber	Clear	No	Bulk = 1 Pc.

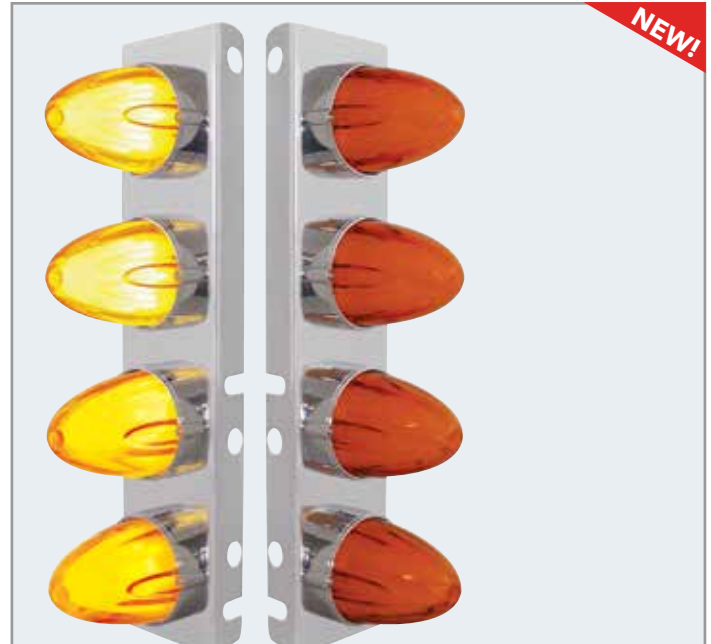

GloLight™

Dual Function

PETERBILT "GLO" LED FRONT AIR CLEANER BRACKET

- Stainless Peterbilt Front Air Cleaner Bracket with Eight 9 "GLO" LED Watermelon Style Auxiliary Lights
- Chrome Plastic Bezel Available Separately, Item # 39209B
- Chrome Plastic Bezel with Visor Available Separately, Item # 39208B

ITEM # W/CRBEZEL	ITEM # W/CRVISOR	LEDS	LENS	PACK
34454	34456	9 Amber x 8	Amber	Bulk = 1 Pair
34455	34457	9 Amber x 8	Clear	Bulk = 1 Pair

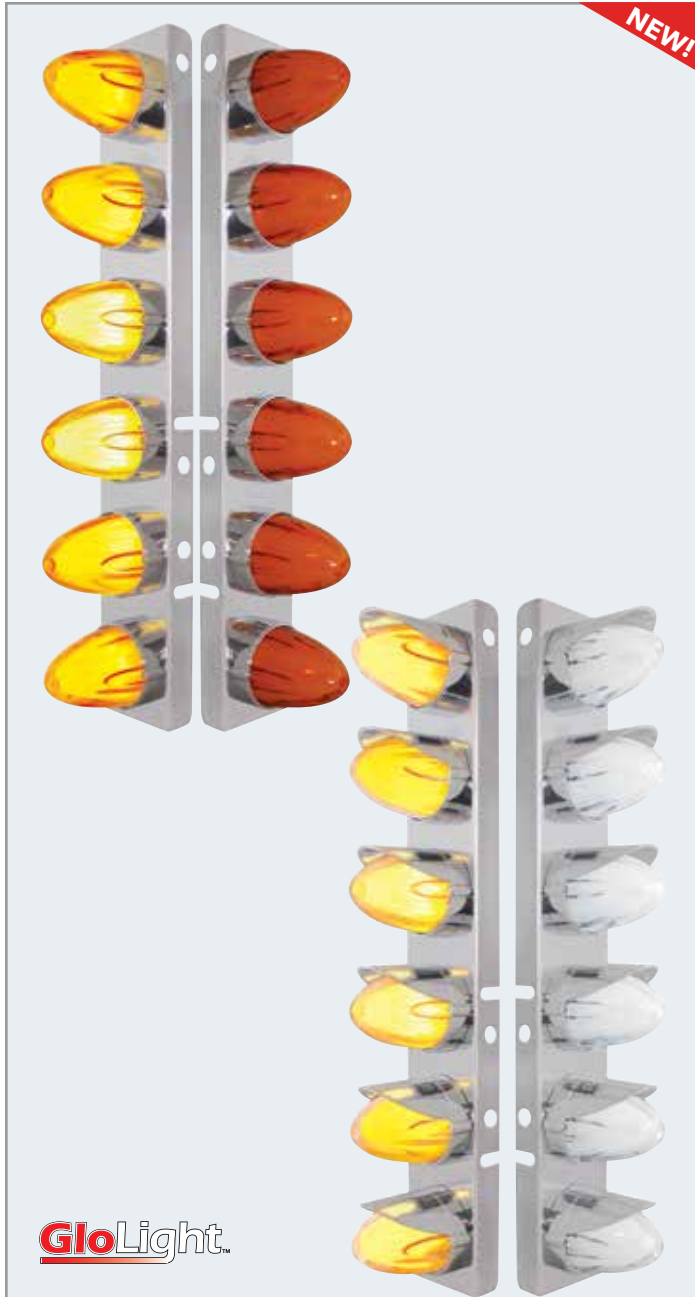

GloLight.

Dual Function

PETERBILT "GLO" LED FRONT AIR CLEANER BRACKET

- Stainless Steel Peterbilt Front Air Cleaner Bracket with Twelve 9 "GLO" LED Watermelon Style Auxiliary Lights
- Chrome Plastic Bezel Available Separately, Item # 39209B
- Chrome Plastic Bezel with Visor Available Separately, Item # 39208B

ITEM # W/CR BEZEL	ITEM # W/CR VISOR	LEDS	LENS	PACK
34458	34460	9 Amber x 12	Amber	Bulk = 1 Pair
34459	34461	9 Amber x 12	Clear	Bulk = 1 Pair



PETERBILT 359 INNER LAMP BUCKET FOR LED HEADLIGHTS

- Complete Inner Lamp Bucket for United Pacific Peterbilt 359 Dual Headlight
- Specifically for LED Headlights, Item # 31267

ITEM #	DESCRIPTION	PACKAGE	PACK
32171-14	LED Lamp Bucket	Bulk	1 Pc.



1998+ PETERBILT / 2001+ KENWORTH 18" CHROME BLADE STEERING WHEEL

- 18" Wheel Rim Steering Wheel with Chrome Spoke for 1998+ Peterbilt and 2001+ Kenworth
- 3 Spoke "Blade" Steering Wheel
- Includes Hub/Horn Assembly

ITEM #	DESCRIPTION	PACKAGE	PACK
88142	Blade Steering Wheel	Boxed	1 Pc./Box



**8 BALL
13/18 SPEED SHIFT KNOB**

- 8 Ball Gearshift Knob for 13/18 Speed
- Brushed Aluminum Mounting Base Adapter
- Includes Mounting Adapter: Item # 70603B for Easy Installation

ITEM #	DESCRIPTION	PACKAGE	PACK
70686	"Glitter" 8 Ball	Carded	1 Pc./Card
70685	8 Ball	Carded	1 Pc./Card



**POOL BALL
13/18 SPEED SHIFT KNOB**

- Pool Ball Gearshift Knob for 13/18 Speed
- Brushed Aluminum Mounting Base Adapter
- Includes Mounting Adapter: Item # 70603B for Easy Installation

ITEM #	DESCRIPTION	PACKAGE	PACK
70687	Number 1 Ball	Carded	1 Pc./Card
70688	Number 2 Ball	Carded	1 Pc./Card
70689	Number 3 Ball	Carded	1 Pc./Card



70025
All Black

70660
Black with Glitter

**8 BALL
SHIFT KNOB**

- 8 Ball Gearshift Knob
- Brushed Aluminum Mounting Base Adapter
- Hex Screw Mount Design, Includes Nylon Reducing Bushings to Fit Smaller Shifters

ITEM #	DESCRIPTION	PACKAGE	PACK
70660	"Glitter" 8 Ball	Carded	1 Pc./Card
70025	8 Ball	Carded	1 Pc./Card



**POOL BALL
SHIFT KNOB**

- Pool Ball Gearshift Knob
- Brushed Aluminum Mounting Base Adapter
- Hex Screw Mount Design, Includes Nylon Reducing Bushings to Fit Smaller Shifters

ITEM #	DESCRIPTION	PACKAGE	PACK
70661	Number 1 Ball	Carded	1 Pc./Card
70662	Number 2 Ball	Carded	1 Pc./Card
70663	Number 3 Ball	Carded	1 Pc./Card



NEW!

DAGGER AIR VALVE KNOB

- Chrome Aluminum Screw On Air Valve Knob
- Available in Chrome or Black Finish
- Fits on Freightliner, Kenworth, Peterbilt and Various Other Trucks

ITEM #	STYLE	FINISH	PACKAGE	PACK
23529	Plain	Black	Carded	1 Pc./Card
23525	Plain	Chrome	Carded	1 Pc./Card



NEW!

1987-93 FOX BODY FORD MUSTANG GT 1993 FOX BODY FORD MUSTANG COBRA FOG LIGHT

- Reproduction Fog Light for 1987-93 Ford Mustang
- Original Glass Lens Design
- Includes Mounting Bracket and Wiring Connectors

ITEM #	DESCRIPTION	OEM NUMBER	PACK
110169	Mustang Fog Light	E7ZZ 15200	1 Pc./Box



NEW!

SKULL WIDE BOTTOM LICENSE FRAME

- Skull Style Wide Bottom Steel License Frame
- Universal Design. Perfect for Cars, Trucks, and Pickups

ITEM #	DESCRIPTION	PACKAGE	PACK
50107	Black / White Skull Style	Carded	1 Pc./Card



NEW!

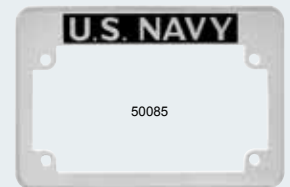

MOTORCYCLE LICENSE PLATE FRAME

- Beautiful Die-Cast Chrome Plated Motorcycle License Plate Frame
- Fits All U.S. Motorcycle License Plates

ITEM #	DESCRIPTION	PACKAGE	PACK
50070	"Live to Ride"	Carded	1 Pc./Card
50082	"U.S. Air Force"	Carded	1 Pc./Card
50083	"U.S. Army"	Carded	1 Pc./Card
50084	"U.S. Marine"	Carded	1 Pc./Card
50085	"U.S. Navy"	Carded	1 Pc./Card



NEW!



DUAL HEADLIGHT WIRING KIT

- Dual Headlight Wire Harness Kit for United Pacific's Peterbilt 359 Style Headlight
- Stainless Steel Wire Loom

ITEM #	DESCRIPTION	PACKAGE	PACK
32171-15	Dual Headlight Wire Harness	Bulk	1 Pc.

HOT!



304 Stainless

STAINLESS PETERBILT 359 STYLE DUAL HEADLIGHT

- 304 Stainless Steel Peterbilt 359 Style Dual Headlight Kit, Light Weight & Less Maintenance than Aluminum Housing
- Includes Crystal Halogen H4 Bulb, Item # 31386
- Stainless Dual Headlight Housing without Inner Lamp Bucket Available Separately, Item # 32190/Drive Side, Item # 32189/Passenger Side,
- Sold Individually, Please Specify Driver or Passenger Side

ITEM #	DESCRIPTION	APPLICATION	PACK
32194	Dual Headlight	Driver	1 Pc./Box
32186	Dual Headlight	Passenger	1 Pc./Box

HOT!



STAINLESS PETERBILT 359 INNER LAMP BUCKET

- Complete Inner Lamp Bucket for United Pacific Peterbilt 359 Dual Headlight, Only for Halogen H4/5006 Bulb

ITEM #	DESCRIPTION	APPLICATION	PACK
32171-13	Inner Lamp Bucket	Bulk	1 Pc.

NEW!



PETERBILT 359 INNER LAMP BUCKET FOR LED HEADLIGHTS

- Complete Inner Lamp Bucket for United Pacific Peterbilt 359 Dual Headlight
- Specifically for LED Headlights, Item # 31267

ITEM #	DESCRIPTION	PACKAGE	PACK
32171-14	LED Lamp Bucket	Bulk	1 Pc.

UN160425

JUNE 2016

WHAT'S NEW



LED Position Light Bar

Dual Function LED Running/Turn Signal



CHROME CENTURY PROJECTION HEADLIGHT WITH LED TURN SIGNAL AND LED POSITION LIGHT BAR

- Chrome Freightliner Century Projection Headlight with LED Turn Signal and LED Position Light Bar
- Fits Various Freightliner Century Models
- Unique Dual LED Position Light Bar
- Replaces the Entire Front Headlight Assembly, **1 Year Warranty**



Color Retail Packaging

Technical Specification

Low Beam Application

H7 Bulb
12V DC Input
4.04 Amps / 48.48 Watt
FMVSS 571

High Beam Application

9006Bulb
12V DC Input
5.2 Amps / 62.4 Watt
FMVSS 571

ITEM #	APPLICATION	DESCRIPTION	PACK
31203	Driver	Chrome	1 Pc./Box
31204	Passenger	Chrome	1 Pc./Box





NEW!

"BLACKOUT" CENTURY PROJECTION HEADLIGHT WITH LED TURN SIGNAL AND LED POSITION LIGHT BAR

- "Blackout" Freightliner Century Projection Headlight with LED Turn Signal and LED Position Light Bar
- Fits Various Freightliner Century Models
- Unique Dual LED Position Light Bar
- Replaces the Entire Front Headlight Assembly, **1 Year Warranty**



BLACKOUT

Color Retail Packaging

Technical Specification

Low Beam Application

H7 Bulb
12V DC Input
4.04 Amps / 48.48 Watt
FMVSS 571

High Beam Application

9006Bulb
12V DC Input
5.2 Amps / 62.4 Watt
FMVSS 571

ITEM #	APPLICATION	DESCRIPTION	PACK
31205	Driver	Blackout	1 Pc./Box
31206	Passenger	Blackout	1 Pc./Box

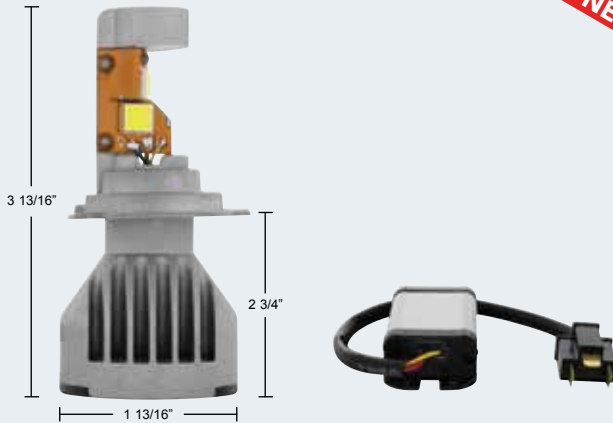

NEW!

HIGH POWER H4 LED BULB

LOW BEAM LIGHT 1000 LUMENS	HIGH BEAM LIGHT 1500 LUMENS	MADE WITH CREE LED
---	--	---------------------------------

- 3 CREE High Power White LED
- 9W Low Beam Application, 18W High Beam Application
- 1000 Lumen Low Beam Output
- 1500 Lumen High Beam Output
- Includes Driver/Controller for Easy Installation, Replaces Any H4 Bulb. Driver/Controller is Approximately 3 1/2" L x 1 3/4" W x 1" H

ITEM #	LED	BULB TYPE	PACKAGE	PACK
36903	3	H4	Carded	1 Pc./Card

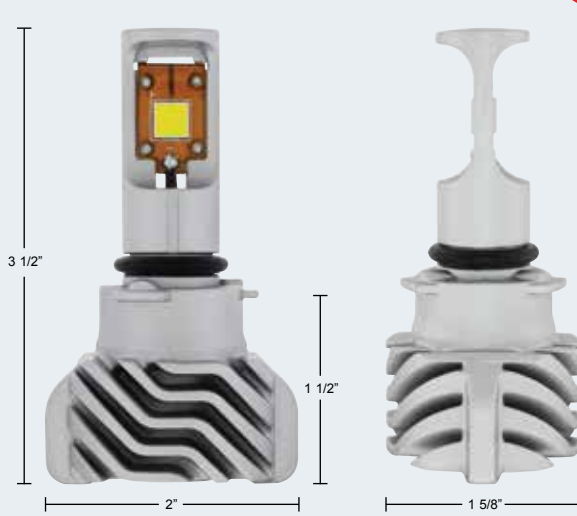

NEW!

HIGH POWER 9006/HB4 LED BULB

LIGHT 1200 LUMENS	HIGH POWER 4.5 WATT X 2 LED	MADE WITH CREE LED
--------------------------------	--	---------------------------------

FANLESS

- 2 CREE High Power White LED
- 10 W Low Beam Application
- Fan Less Design
- 1200 Lumen Output

ITEM #	LED	BULB TYPE	PACKAGE	PACK
36904	2	9006/HB4	Carded	1 Pc./Card

NEW!



88248

88249



88250



Color Retail Packaging

18" FLAME STEERING WHEEL

- 18" Wood Steering Wheel with Chrome Spoke and Hydro-Dip Flame Finish
- Available in 4 Spoke, Boss, or Lady
- Steering Wheel Only, **Hub and Horn Assembly Available Separately**
- Mix and Match with United Pacific Hub and Horn Bezel for a Unique and Distinctive Look

ITEM #	PATTERN	STYLE	PACKAGE	PACK
88248	Flame	4 Spoke	Boxed	1 Pc./Box
88249	Flame	Boss	Boxed	1 Pc./Box
88250	Flame	Lady	Boxed	1 Pc./Box

NEW!



Color Retail Packaging

7" CRYSTAL HEADLIGHT WITH 6 AMBER AUXILIARY LED

- Super Quality with Reinforced Multi-Surfaced, Aluminum Reflector
- 6 Amber Hi/Low Function LED's
- Rugged Anti-Vibration Construction
- Includes 9007 Halogen Bulb and Seal Beam/H4 Plug Adapter
- DOT/SAE: HR 15, LED's for Auxiliary/Utility Purposes
- 12V, Dual Function Auxiliary LED's Have Three Wire Hookup

ITEM #	DESCRIPTION	PACKAGE	PACK
31247	7" Headlight	Boxed	1 Pc./Box

NEW!



2004-14 VOLVO VNL CHROME HOOD MIRROR

- Chrome Mirror Assembly for 2004-14 Volvo VNL
- Includes Complete Mirror and Mounting Arm
- Sold Individually, Please Specify Driver or Passenger Side

ITEM #	OEM NUMBER	APPLICATION	PACK
41695	82361058	Driver	1 Pc./Box
41696	82361059	Passenger	1 Pc./Box



NEW!

STAINLESS 19 LED LIGHT BAR BRACKET

- Stainless Steel Light Bracket with One 19 LED 17" S/T/T Light Bar, Item # 36887
- LED 17" Light Bar Available with Chrome Bezel
- Stainless Steel Light Bracket Available Separately: Item # 20900B
- Chrome Plastic Bezel Available Separately: Item # 34047B

ITEM #	LEDS	LENS	BEZEL	PACK
36708	19 Red	Red	Yes	Bulk = 1 Pc.
36709	19 Red	Red	No	Bulk = 1 Pc.



NEW!

STAINLESS 19 LED LIGHT BAR DOUBLE FACE BRACKET

- Stainless Steel Double Face Light Bracket with Two 19 LED 17" S/T/T Light Bar, Item # 36887
- LED 17" Light Bar Available with Chrome Bezel
- Stainless Double Face Light Bracket Available Separately: Item # 20913B
- Chrome Plastic Bezel Available Separately: Item # 34047B

ITEM #	LEDS	LENS	BEZEL	PACK
36710	19 Red	Red	Yes	Bulk = 1 Pc.
36711	19 Red	Red	No	Bulk = 1 Pc.



NEW!

CHROME TOP MUD FLAP PLATE W/19 LED LIGHT BAR

- Chrome Top Plate with 19 LED Light Bar, Stud Mounted
- LED 17" Light Bar Available with Chrome Bezel
- Chrome Top Mud Flap Plate Available Separately: Item # 10399
- Chrome Plastic Bezel Available Separately: Item # 34047B

ITEM #	LEDS	LENS	BEZEL	PACK
36712	19 Red	Red	Yes	Bulk = 1 Pc.
36713	19 Red	Red	No	Bulk = 1 Pc.

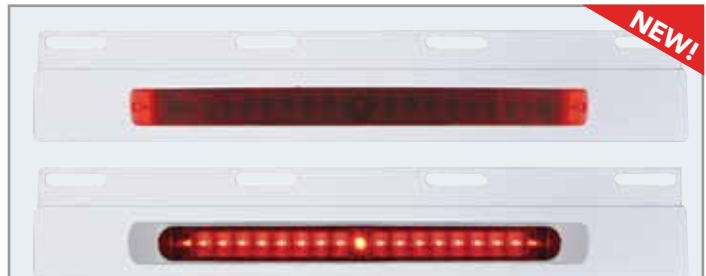

NEW!

STAINLESS TOP MUD FLAP PLATE W/19 LED LIGHT BAR

- Stainless Steel Top Mud Flap Plate with 19 LED Light Bar
- LED 17" Light Bar Available with Chrome Bezel
- Stainless Steel Top Mud Flap Bracket Available Separately: Item # 21396
- Chrome Plastic Bezel Available Separately: Item # 34047B

ITEM #	LEDS	LENS	BEZEL	PACK
36714	19 Red	Red	Yes	Bulk = 1 Pc.
36715	19 Red	Red	No	Bulk = 1 Pc.



NEW!

STAINLESS 19 LED 94" LIGHT BAR BRACKET

- 94" x 1 7/8" Stainless Steel Light Bracket with Five LED Light Bar
- LED 17" Light Bar Available with Chrome Bezel
- Stainless Steel Light Bracket Available Separately: Item # 20872
- Chrome Plastic Bezel Available Separately: Item # 34047B

ITEM #	LEDS	LENS	BEZEL	PACK
36716	19 Red	Red	Yes	Bulk = 1 Pc.
36717	19 Red	Red	No	Bulk = 1 Pc.



NEW!

**CHROME
T 13/15/18 SPEED SHIFT KNOB**

- T Shift Knob for 13/15/18 Speed Gearshift Knob
- 1" Top Mount Gearshift Mounting Adapter
- Mounting Adapter, Item # 70604B and T Shift Knob: Item # 70666 Available Separately
- *Patent Pending*

ITEM #	DESCRIPTION	PACKAGE	PACK
70692	T 13/15/18 Speed Shift Knob	Carded	1 Pc./Card



NEW!

"GATLING" 13/15/18 SPEED SHIFT KNOB

- "Gatling" Pistol Grip Shift Knob for 13/15/18 Speed Gearshift Knob
- Mounting Adapter, Item # 70603B and "Gatling" Pistol Grip Knob: Item # 70672 (Black)/70651 (Chrome) Available Separately
- *Patent Pending*

ITEM #	STYLE	FINISH	PACKAGE	PACK
70693	Gatling	Black	Carded	1 Pc./Card
70683	Gatling	Chrome	Carded	1 Pc./Card



NEW!

**CHROME
T SHIFT KNOB - 1" MOUNT**

- Ultra High Quality Finish, Fits United Pacific Mounting Adapter Only
- Heavy Duty Construction Ensures Strength and Durability

1"

ITEM #	DESCRIPTION	PACKAGE	PACK
70666	T Shift Knob	Carded	1 Pc./Card



NEW!

"GATLING" PISTOL GRIP SHIFT KNOB

- "Gatling" Pistol Grip Shift Knob
- Available in Chrome or Black
- Universal Hex Screw Mount Design, Includes Mounting Hardware

Mounting Hardware

ITEM #	STYLE	FINISH	PACKAGE	PACK
70672	Gatling	Black	Carded	1 Pc./Card
70651	Gatling	Chrome	Carded	1 Pc./Card



CHROME T 13/15/18 SPEED SHIFT KNOB

- T Shift Knob for 13/15/18 Speed Gearshift Knob
- 1" Top Mount Gearshift Mounting Adapter
- Mounting Adapter, Item # 70604B and T Shift Knob: Item # 70666 Available Separately
- *Patent Pending*

ITEM #	DESCRIPTION	PACKAGE	PACK
70692	T 13/15/18 Speed Shift Knob	Carded	1 Pc./Card



"GATLING" 13/15/18 SPEED SHIFT KNOB

- "Gatling" Pistol Grip Shift Knob for 13/15/18 Speed Gearshift Knob
- Mounting Adapter, Item # 70603B and "Gatling" Pistol Grip Knob: Item # 70672 (Black)/70651 (Chrome) Available Separately
- *Patent Pending*

ITEM #	STYLE	FINISH	PACKAGE	PACK
70693	Gatling	Black	Carded	1 Pc./Card
70683	Gatling	Chrome	Carded	1 Pc./Card



CHROME T SHIFT KNOB - 1" MOUNT

- Ultra High Quality Finish, Fits United Pacific Mounting Adapter Only
- Heavy Duty Construction Ensures Strength and Durability

ITEM #	DESCRIPTION	PACKAGE	PACK
70666	T Shift Knob	Carded	1 Pc./Card



"GATLING" PISTOL GRIP SHIFT KNOB

- "Gatling" Pistol Grip Shift Knob
- Available in Chrome or Black
- Universal Hex Screw Mount Design, Includes Mounting Hardware

ITEM #	STYLE	FINISH	PACKAGE	PACK
70672	Gatling	Black	Carded	1 Pc./Card
70651	Gatling	Chrome	Carded	1 Pc./Card



"SLOT" 13/15/18 SPEED SHIFT KNOB

- "Slot" Pistol Grip Shift Knob
- For 13/15/18 Speed Gearshift Knob
- Mounting Adapter, Item # 70603B and "Gatling" Pistol Grip Knob: Item # 70673 (Black)/70659 (Chrome) Available Separately
- *Patent Pending*

ITEM #	STYLE	FINISH	PACKAGE	PACK
70694	Slot	Black	Carded	1 Pc./Card
70684	Slot	Chrome	Carded	1 Pc./Card



SKULL DAGGER AIR VALVE KNOB

- Skull Dagger Screw On Air Valve Knob
- Available in Chrome or Black
- Fits on Freightliner, Kenworth, Peterbilt and Various Other Trucks

ITEM #	STYLE	FINISH	PACKAGE	PACK
23579	Skull	Black	Carded	1 Pc./Card
23578	Skull	Chrome	Carded	1 Pc./Card



"SLOT" PISTOL GRIP SHIFT KNOB

- "Slot" Pistol Grip Shift Knob
- Available in Chrome or Black
- Universal Hex Screw Mount Design, Includes Mounting Hardware

ITEM #	STYLE	FINISH	PACKAGE	PACK
70673	Slot	Black	Carded	1 Pc./Card
70659	Slot	Chrome	Carded	1 Pc./Card



MULTI PURPOSE 5 SWITCH CONTROL PANEL

- Multi Purpose 5 Switch Control Panel for United Pacific Directional / Warning Light Bar
- Allow User to Select Desired Warning and Flash Pattern

ITEM #	DESCRIPTION	PACKAGE	PACK
40086	5 Switch Control	Boxed	1 Pc./Box



Deluxe Vintage Design

LED MOTORCYCLE LICENSE PLATE FRAME

- Chrome Die Cast Motorcycle License Plate Frame with LED License Plate Light and 11 LED License Light
- Rear Facing Light Available in Red, Amber or White

ITEM #	LEDS	FUNCTION	PACKAGE	PACK
110205	5 Red	3rd Brake	Carded	1 Pc./Card
110211	8 White	Back-Up	Carded	1 Pc./Card
110210	5 Amber	Auxiliary	Carded	1 Pc./Card



CHROME FLUSH MOUNT LED LICENSE PLATE LIGHT

- Beautiful Chrome Die Cast Art-Deco Design Light Housing
- White LED License Plate Light with 11 LED
- Rear Facing Light Available in Red, Amber or White
- Includes Mounting Pad with Lip and Mounting Hardware

ITEM #	LEDS	FUNCTION	PACKAGE	PACK
110203	5 Red	3rd Brake	Carded	1 Pc./Card
110204	8 White	Back-Up	Carded	1 Pc./Card
110265	5 Amber	Auxiliary	Carded	1 Pc./Card



LED MOTORCYCLE LICENSE BRACKET

- Chrome Die Cast Motorcycle License Bracket with LED License Plate Light and 11 LED License Light
- Rear Facing Light Available in Red, Amber or White

ITEM #	LEDS	FUNCTION	PACKAGE	PACK
S2007LED	5 Red	3rd Brake	Carded	1 Pc./Card
S2007LED-W	8 White	Back-Up	Carded	1 Pc./Card
S2007LED-A	5 Amber	Auxiliary	Carded	1 Pc./Card



CHROME SKULL MOTORCYCLE LICENSE FRAME

- Chrome Die-Cast Skull Motorcycle License Frame
- Universal Design, Fits All U.S. Motorcycle License Plates

ITEM #	DESCRIPTION	PACKAGE	PACK
50065	Skull License Frame	Carded	1 Pc./Card
50075	Designer Skull License Frame	Carded	1 Pc./Card

UN160525

JULY 2016

WHAT'S NEW



LED Side Reflector

LED Position Light Bar

LED Turn Signal



CHROME 2008+ KENWORTH T660 PROJECTION HEADLIGHT WITH LED TURN SIGNAL & LED POSITION LIGHT BAR

- Chrome Kenworth T660 Projection Headlight with 10 LED Turn Signal and 40 LED Accent Strip Daytime Running Light
- Fits All 2008+ Kenworth T660 Models
- DOT/SAE Approved
- Sold Individually, Please Specify Driver or Passenger Side, **1 Year Warranty**



Color Retail Packaging

Technical Specification

Low Beam Application
12V DC Input
4.1 Amps / 49.2 Watt
FMVSS 571

High Beam Application
12V DC Input
5.1 Amps / 61.2 Watt
FMVSS 571

ITEM #	APPLICATION	DESCRIPTION	PACK
31517	Driver	Chrome	1 Pc./Box
31518	Passenger	Chrome	1 Pc./Box



NEW!



LED Side Reflector

LED Position Light Bar

LED Turn Signal



"BLACKOUT" 2008+ KENWORTH T660 PROJECTION HEADLIGHT WITH LED TURN SIGNAL & LED POSITION LIGHT BAR

- "Blackout" Kenworth T660 Projection Headlight with 10 LED Turn Signal and 40 LED Accent Strip Daytime Running Light
- Fits All 2008+ Kenworth T660 Models
- DOT/SAE Approved
- Sold Individually, Please Specify Driver or Passenger Side, **1 Year Warranty**



Color Retail Packaging

Technical Specification

Low Beam Application	High Beam Application
12V DC Input	12V DC Input
4.1 Amps / 49.2 Watt	5.1 Amps / 61.2 Watt
FMVSS 571	FMVSS 571

ITEM #	APPLICATION	DESCRIPTION	PACK
31463	Driver	Blackout	1 Pc./Box
31464	Passenger	Blackout	1 Pc./Box





NEW!

1996-05 FREIGHTLINER CENTURY 5 LED HEADLIGHT

- Fits 1996-2005 Freightliner Century Models
- Available in Chrome or Black
- SAE Approved Headlight, Wire Harness Not Included
- 5 LED Headlight Available Separately: Item # 31391/31289
- Headlight Housing Available Separately: Item # 31279

ITEM #	DESCRIPTION	PACKAGE	PACK
31139	Chrome 5 LED Headlight	Boxed	1 Pc./Box
31140	Black 5 LED Headlight	Boxed	1 Pc./Box



NEW!



Color Retail Packaging

1996-05 FREIGHTLINER CENTURY CRYSTAL HEADLIGHT

- Fits 1996-2005 Freightliner Century Models
- SAE Approved Headlight, Wire Harness Not Included
- Crystal Headlight Available Separately: Item # 31387
- Headlight Housing Available Separately: Item # 31279

ITEM #	DESCRIPTION	PACKAGE	PACK
31280	Crystal Headlight	Boxed	1 Pc./Box



NEW!



Color Retail Packaging

1996-05 FREIGHTLINER CENTURY CRYSTAL HEADLIGHT WITH LED HALO RING

- Fits 1996-2005 Freightliner Century Models
- Available in Amber or White LED Halo Ring
- SAE Approved Headlight, Wire Harness Not Included
- Crystal Headlight with LED Halo Ring Available Separately: Item # 31284/31285
- Headlight Housing Available Separately: Item # 31279

ITEM #	DESCRIPTION	PACKAGE	PACK
31281	Amber LED Halo Ring	Boxed	1 Pc./Box
31282	White LED Halo Ring	Boxed	1 Pc./Box



NEW!

1996-05 FREIGHTLINER CENTURY 34 LED CRYSTAL HEADLIGHT

- Fits 1996-2005 Freightliner Century Models
- Available in Amber or White LEDs
- SAE Approved Headlight, Wire Harness Not Included
- 34 LED Crystal Headlight Available Separately: Item # 31378/31379
- Headlight Housing Available Separately: Item # 31279

ITEM #	DESCRIPTION	PACKAGE	PACK
31141	Amber LED Crystal Headlight	Boxed	1 Pc./Box
31142	White LED Crystal Headlight	Boxed	1 Pc./Box



NEW!

1996-05 FREIGHTLINER CENTURY CRYSTAL HEADLIGHT WITH 6 AMBER AUXILIARY LED

- Fits 1996-2005 Freightliner Century Models
- SAE Approved Headlight, Wire Harness Not Included
- Crystal Headlight with 6 Amber Auxiliary LED Available Separately: Item # 31247
- Headlight Housing Available Separately: Item # 31279

ITEM #	DESCRIPTION	PACKAGE	PACK
31143	Headlight with Auxiliary LED	Boxed	1 Pc./Box



NEW!



GloLight.



11 LED FREIGHTLINER "GLO" CAB LIGHT

- 11 LED Freightliner "GLO" Cab Light
- Fits Various Freightliner Models and Years
- Unique Patent Pending "GLO" Design
- Available in Amber or Clear Lens
- Hard Wired with Two .180 Bullet Plugs

ITEM #	LEDS	LENS	PACKAGE	PACK
36632	11 Amber	Amber	Carded	1 Pc./Card
36633	11 Amber	Clear	Carded	1 Pc./Card



NEW!



Color Retail Packaging

1996-05 FREIGHTLINER CENTURY HEADLIGHT HOUSING

- Fits 1996-2005 Freightliner Century Models
- Universal Design, Fits All 7" Round Headlight
- Removable Black Cover for Easy Installation and Wiring

ITEM #	DESCRIPTION	PACKAGE	PACK
31279	Headlight Housing	Boxed	1 Pc./Box



NEW!



Color Retail Packaging

2003+ VOLVO VN/VNL FOG/DRIVING LIGHT WITH WHITE LED LIGHT BAR

- Fit 2003+ Volvo VN/VNL Models
- Easy Installation, Fits OEM Housing & Plug into Existing Wiring
- Unique Dual LED Light Bar Design
- Sold Individually, Please Specify Driver or Passenger Side

ITEM #	APPLICATION	DESCRIPTION	PACK
32648	Driver	Fog Light w/ LED Light Bar	1 Pc./Box
32649	Passenger	Fog Light w/ LED Light Bar	1 Pc./Box

NEW!



6 LED PICKUP CAB MARKER LIGHT

- 6 LED Cab Marker Light for Pickup
- Hard Wired with 2 Wires
- Fits Various Standard Pickup Truck
- Includes Mounting Gasket

ITEM #	LEDS	LENS	PACKAGE	PACK
36621B	6 Amber	Amber	Bulk	1 Pc.
36622B	6 Amber	Clear	Bulk	1 Pc.

NEW!



33 MM x 4 1/8" SPIKE NUT COVER - THREAD-ON

- 33 mm Thread-On Nut Spike Covers
- Available in Chrome or Black
- All Nut Covers are Flanged to Cover Up the Nut Flange

ITEM #	DESCRIPTION	PACKAGE	PACK
10000B	Black Spike Nut Cover	Bulk	1 Pc.
10007B	Chrome Spike Nut Cover	Bulk	1 Pc.

NEW!



CHROME 8 1/2" CONVEX MIRROR

- 8 1/2" Round Chrome Mirror Housing
- Stainless Steel Mirror Arm
- Molded Mounting Hardware Included
- Available with Center or Offset Stud
- Universal Application, Left or Right Hand Installation

Color Retail Packaging

ITEM #	SIZE	STUD	PACKAGE	PACK
60048	8 1/2"	Center	Boxed	1 Pc./Box
60049	8 1/2"	Offset	Boxed	1 Pc./Box

NEW!



CHROME UNIVERSAL 7/16" LIP FRONT HUB CAP WITH 3 EXTRA LARGE BAR STRAIGHT SPINNER

- Chrome Universal Notched 7/16" Lip Front Hub Cap with Spinner
- Fits 4, 5 or 6 Notched Hubs, May Not Fits Some 4 Even Notched Hub
- Straight Spinner Available Separately: Item # 10722
- 7/16" Lip Designer for Steel Wheel

ITEM #	DESCRIPTION	PACKAGE	PACK
10247	7/16" Lip Front Hub Cap	Bulk	1 Pc.



NEW!



**CHROME
DAGGER 13/15/18 SPEED SHIFT KNOB**

- Dagger Style Shift Knob for 13/15/18 Speed Gearshift Knob
- Available in Dagger or Skull Dagger Style
- Mounting Adapter, Item # 70603B and Dagger Knob: Item # 70677 (Dagger)/70679(Skull) Available Separately
- *Patent Pending*

ITEM #	STYLE	FINISH	PACKAGE	PACK
70695	Dagger	Chrome	Carded	1 Pc./Card
70696	Skull	Chrome	Carded	1 Pc./Card

NEW!



**CHROME
T SHIFT KNOB**

- Chrome "T" Shift Knob, Vertical Mount, CNC-Machined Grip
- Designed for Custom Modification of Modern Single Stick Shifter to Old School Dual Stick Shift System
- Mounting Adaptor Item # 70625B And "T" Shift Knob Grip Item # 70653 Available Separately

ITEM #	DESCRIPTION	PACKAGE	PACK
70697	T Shift Knob	Carded	1 Pc./Card

NEW!



**CHROME
DAGGER SHIFT KNOB**

- Dagger Style Shift Knob
- Available in Dagger or Skull Dagger Style
- Ultra High Quality Chrome Finish, Machined Grip
- Universal Hex Screw Mount Design, Includes Mounting Hardware

ITEM #	STYLE	FINISH	PACKAGE	PACK
70677	Dagger	Chrome	Carded	1 Pc./Card
70679	Skull	Chrome	Carded	1 Pc./Card

NEW!



**CHROME
T SHIFT KNOB**

- Ultra High Quality Finish
- Heavy Duty Construction Ensures Strength and Durability

ITEM #	DESCRIPTION	PACKAGE	PACK
70653	T Shift Knob	Carded	1 Pc./Card

AUGUST 2016 WHAT'S NEW



DUAL FUNCTION AMBER LED LIGHT BAR



DUAL FUNCTION AMBER LED LIGHT BAR



1996+ FREIGHTLINER COLUMBIA PROJECTION HEADLIGHT WITH DUAL FUNCTION AMBER LED LIGHT BAR

- Freightliner Columbia Projection Headlight with Dual Function Amber LED Light Bar
- Fits Various 1996+ Freightliner Columbia Models
- DOT/SAE Approved
- Available in Chrome or Black Design
- Sold Individually, Please Specify Driver or Passenger Side, **1 Year Warranty**

Technical Specification

Low Beam Application
12V DC Input
3.9 Amps / 46.8 Watt
FMVSS 571

High Beam Application
12V DC Input
4.5 Amps / 54 Watt
FMVSS 571

ITEM #	APPLICATION	DESCRIPTION	PACK
31187	Driver	Chrome	1 Pc./Box
31188	Passenger	Chrome	1 Pc./Box
31224	Driver	Blackout	1 Pc./Box
31225	Passenger	Blackout	1 Pc./Box

FREIGHTLINER CASCADIA PROJECTION HEADLIGHT WITH DUAL FUNCTION AMBER LED LIGHT BAR

- Freightliner Cascadia Projection Headlight with Dual Function Amber LED Light Bar
- Fits Various Freightliner Columbia Models
- DOT/SAE Approved
- Available in Crystal or Black Design
- Sold Individually, Please Specify Driver or Passenger Side, **1 Year Warranty**

Technical Specification

Low Beam Application
12V DC Input
4.0 Amps / 48 Watt
FMVSS 108

High Beam Application
12V DC Input
4.66 Amps / 55.92 Watt
FMVSS 108

ITEM #	APPLICATION	DESCRIPTION	PACK
31226	Driver	Chrome	1 Pc./Box
31227	Passenger	Chrome	1 Pc./Box
31228	Driver	Blackout	1 Pc./Box
31229	Passenger	Blackout	1 Pc./Box



NEW!

7" CLASSIC HEADLIGHT WITH 6 AMBER AUXILIARY LED

- Complete Assembly, Available in Stainless or Chrome
- Crystal Headlight Bulb with Amber Hi/Low Function LED's
- DOT/SAE: HR 15, LED's for Auxiliary/Utility Purposes
- Crystal Headlight with 6 Amber Auxiliary LED Available Separately: Item # 31247
- Headlight Housing Available Separately: Item # 30368 (Stainless)/30375 (Chrome)
- 12V, Dual Function Auxiliary LED's Have Three Wire Hookup

ITEM #	DESCRIPTION	FINISH	PACK
32508	7" Classic Headlight	Stainless	1 Pc./Box
32509	7" Classic Headlight	Chrome	1 Pc./Box



NEW!

**HIGH POWER
10 WATT X 2
LED**

**MADE WITH
CREE
LED**



2008+ FREIGHTLINER CASCADIA LED FOG/DRIVING LIGHT ASSEMBLY

- Fits 2008+ Freightliner Cascadia Model
- Manufactured with Two 10 Watt "Cree" High Power LED
- Replacement for OEM # A06-51909-000/ A06-51909-001
- Easy Installation, Fits OEM Housing and Plug into Existing Wiring

ITEM #	DESCRIPTION	APPLICATION	PACK
31222	LED Fog/Driving Light	Driver	1 Pc./Box
31223	LED Fog/Driving Light	Passenger	1 Pc./Box



NEW!

4 HIGH POWER LED "X2" LIGHT - BRACKET MOUNT

- Four 3W High Power LED
- Available in Flood or Spot Pattern
- Die-Casting Aluminum Housing, Polycarbonate Lens
- Integrated Thermal Management
- Bracket Mount, Mounting Screw Included

**LIGHT
1400
LUMENS**
X2

ITEM #	LEDS	FUNCTION	IP RATING	PACK
36533	3 Watt x 4	Flood	IP68	1 Pc./Box
36534	3 Watt x 4	Spot	IP68	1 Pc./Box



NEW!

4 HIGH POWER LED "X2" LIGHT - FLUSH MOUNT

- Four 3W High Power LED
- Available in Flood or Spot Pattern
- Die-Casting Aluminum Housing, Polycarbonate Lens
- Integrated Thermal Management
- Flush Mount, Mounting Screw Included

**LIGHT
1400
LUMENS**
X2

ITEM #	LEDS	FUNCTION	IP RATING	PACK
36535	3 Watt x 4	Flood	IP68	1 Pc./Box
36536	3 Watt x 4	Spot	IP68	1 Pc./Box



PETERBILT DASH CONTROL KNOB

- Chrome Plastic Peterbilt Dash Data Display Module Control Knob
- Direct Replacement of OEM Control Knob

ITEM #	DESCRIPTION	PACKAGE	PACK
41738	Control Knob	Carded	1 Pc./Card



SKULL DASH KNOB

- Designer Skull Dash Knob
- Zinc Die-Casted, Available in Chrome or Matte Black Finish
- Universal Hex Screw Mount Design

ITEM #	DESCRIPTION	FINISH	PACK
23197	Skull Dash Knob	Chrome	1 Pc./Card
23198	Skull Dash Knob	Black	1 Pc./Card



KNUCKLE 13/15/18 SPEED SHIFT KNOB

- Knuckle Style Shift Knob for 13/15/18 Speed Gearshift Knob
- Zinc Die-Casted, Available in Chrome or Matte Black Finish
- Mounting Adapter, Item # 70603B and Knuckle Knob: Item # 70690 (Black)/70652 (Chrome) Available Separately
- *Patent Pending*

ITEM #	STYLE	FINISH	PACKAGE	PACK
70598	Knuckle	Black	Carded	1 Pc./Card
70599	Knuckle	Chrome	Carded	1 Pc./Card



KNUCKLE SHIFT KNOB

- Knuckle Shift Knob
- Zinc Die-Casted, Available in Chrome or Matte Black Finish
- Universal Hex Screw Mount Design, Includes Mounting Hardware

ITEM #	STYLE	FINISH	PACKAGE	PACK
70690	Knuckle	Black	Carded	1 Pc./Card
70652	Knuckle	Chrome	Carded	1 Pc./Card



NEW & IMPROVED BACK IN STOCK!

NEW!

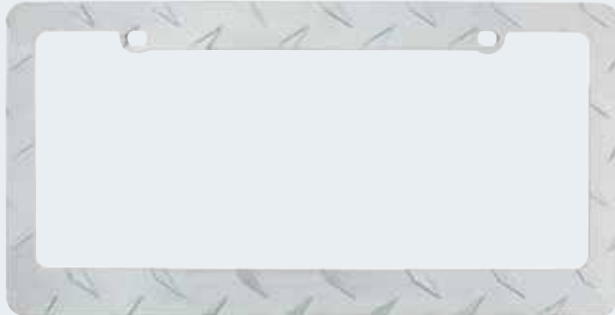

CHROME DIAMOND PLATE LICENSE FRAME

- Chrome Zinc Die-Casted Diamond Plate Designer License Frame
- Universal Design, Perfect for Cars, Trucks, and Pickups

ITEM #	DESCRIPTION	PACKAGE	PACK
50135	Diamond Plate Frame	Carded	1 Pc./Card



NEW!

CHROME 7" MOTORCYCLE HEADLIGHT - GROOVED WITH 6 AMBER AUXILIARY LED

- Complete Assembly, Chrome Finished
- Fits 1986-2011 Heritage, Fat Boy, and FLSTN Softail
- Crystal Headlight Bulb with Amber Hi/Low Function LED's
- DOT/SAE: HR 15, LED's for Auxiliary/Utility Purposes
- Crystal Headlight with 6 Amber Auxiliary LED Available Separately: Item # 31247
- Headlight Housing Available Separately: Item # 32169
- 12V, Dual Function Auxiliary LED's Have Three Wire Hookup

ITEM #	DESCRIPTION	PACKAGE	PACK
32699	7" Motorcycle Headlight	Boxed	1 Pc./Box



NEW!

CHROME HUB CAP WITH 3 EXTRA LARGE BAR STRAIGHT SPINNER

- Chrome Plastic Hub Cap with 3 Extra Large Bar Straight Spinner for United Pacific Axle Cover Sets
- Front Hub Cap Only Fits United Pacific Front Axle Cover Kit: Item # 10260 and Item # 10262, Will Not Fit Economy Front Axle Cover: Item # 10251
- Rear Hub Cap Only Fits United Pacific Rear Axle Cover Kit: Item # 10264 and Item # 10266, Will Not Fit Economy Rear Axle Cover: Item # 10263 & 10256

ITEM #	DESCRIPTION	APPLICATION	PACK
10313	Hub Cap Spinner	Front	1 Pc.
10314	Hub Cap Spinner	Rear	1 Pc.



NEW!

CHROME 8" REAR HUB CAP WITH 3 EXTRA LARGE BAR STRAIGHT SPINNER

- Chrome Plastic 8" Rear Hub Cap with 3 Extra Large Bar Straight Spinner
- 8 1/2" Dia. Axle with 8 of 5/8" Studs
- Straight Spinner Available Separately: Item # 10722

ITEM #	INNER DIA.	MATERIAL	PACKAGE	PACK
10309	8"	Chrome	Bulk	1 Pc.

UN160725

SEPTEMBER 2016
WHAT'S NEW



**Complete Combo Kit
 in 1 Color Retail Box.
 Front Axle Cover Kit
 (2 Each), Rear Axle
 Cover Kit (4 Each),
 And Nut Cover Tool (1 Pc.),
 All In 1 Color Retail Box**



**33mm
 Thread-On**

REAR AXLE COVER KIT x 4

Item # 10263



FRONT AXLE COVER KIT x 2

Item # 10257



**NUT COVER
 TOOL**

Item # 10259



AXLE COVER COMBO KIT - 33mm

- Chrome Plastic Axle Cover Combo Kit
- Includes Everything You Need to Dress Up Your Wheels
- Kit Includes:
 - Chrome Plastic Front Axle Cover x 2
 - Chrome Plastic Rear Axle Cover x 4
 - Chrome Plastic 33mm Thread-On Nut Cover x 60
 - Nut Cover Tool x 1

ITEM #	STYLE	SIZE	PACKAGE	PACK
10305	Dome	33mm Thread-On	Color Box	1 Kit./Box



DUAL FUNCTION AMBER LED LIGHT BAR

NEW!



Technical Specification

Low Beam Application
12V DC Input
4.17 Amps / 50.04 Watt
FMVSS 571

High Beam Application
12V DC Input
4.32 Amps / 51.84 Watt
FMVSS 571

2008+ PETERBILT 386/387 PROJECTION HEADLIGHT WITH DUAL FUNCTION AMBER LED LIGHT BAR

- Peterbilt 386/387 Projection Headlight with Dual Function Amber LED Light Bar
- Fits All 2008+ Peterbilt 386/387 Models, DOT/SAE Approved
- Available in Chrome or Blackout Design
- Sold Individually, Please Specify Driver or Passenger Side, **1 Year Warranty**

ITEM #	FINISH	APPLICATION	PACKAGE	PACK
31252	Chrome	Driver	Color Box	1 Pc./Box
31253	Chrome	Passenger	Color Box	1 Pc./Box
31239	Blackout	Driver	Color Box	1 Pc./Box
31240	Blackout	Passenger	Color Box	1 Pc./Box

DUAL FUNCTION AMBER LED LIGHT BAR

NEW!



Technical Specification

Low Beam Application
12V DC Input
4.1 Amps / 49.2 Watt
FMVSS 571

High Beam Application
12V DC Input
4.5 Amps / 54 Watt
FMVSS 571

2004+ VOLVO VN/VNL PROJECTION HEADLIGHT WITH DUAL FUNCTION AMBER LED LIGHT BAR

- Volvo VN/VNL Projection Headlight with Dual Function Amber LED Light Bar
- Fits All 2004+ Volvo VN/VNL Models, DOT/SAE Approved
- Available in Chrome or Blackout Design
- Sold Individually, Please Specify Driver or Passenger Side, **1 Year Warranty**

ITEM #	FINISH	APPLICATION	PACKAGE	PACK
31230	Chrome	Driver	Color Box	1 Pc./Box
31231	Chrome	Passenger	Color Box	1 Pc./Box
31232	Blackout	Driver	Color Box	1 Pc./Box
31233	Blackout	Passenger	Color Box	1 Pc./Box



1998-2010 STERLING HEADLIGHT ASSEMBLY

- Headlight Assembly for 1998-2010 Sterling
- Includes Bulb and Housing
- DOT and SAE Approved
- Sold Individually, Please Specify Driver or Passenger Side, **1 Year Warranty**

ITEM #	APPLICATION	OEM NUMBER	PACKAGE	PACK
31163	Driver	A1713344001	Box	1 Pc./Box
31164	Passenger	A1713344000	Box	1 Pc./Box



NEW!



NEW!

CHROME 2004+ VOLVO VN/VNL FOG/DRIVING LIGHT ASSEMBLY

- DRL & Fog Lamp Assembly for 2004+ Volvo VN/VNL Trucks
- Complete Assembly with Wire Harness
- Sold Individually, Please Specify Driver or Passenger Side

ITEM #	APPLICATION	OEM NUMBER	PACKAGE	PACK
32590	Driver	20737496	Color Box	1 Pc./Box
32591	Passenger	20737497	Color Box	1 Pc./Box



NEW!

CHROME 2004+ VOLVO VN/VNL FOG LIGHT ASSEMBLY

- Fog Lamp Assembly for 2004+ Volvo VN/VNL Trucks
- Complete Assembly with Wire Harness, Fog Light Only
- Sold Individually, Please Specify Driver or Passenger Side

ITEM #	APPLICATION	OEM NUMBER	PACKAGE	PACK
32592	Driver	20737500	Color Box	1 Pc./Box
32593	Passenger	20737501	Color Box	1 Pc./Box

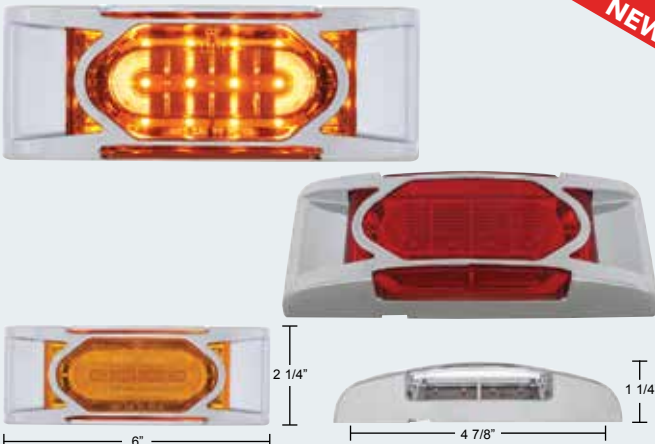

NEW!

16 LED REFLECTOR CLEARANCE/MARKER LIGHT WITH CHROME BEZEL

- 16 LED Rectangular Clearance/Marker Light with Chrome Bezel
- Unique Reflector Design Projects Light in Multiple Directions
- Hardwired Two Wires, **Lifetime Warranty**

ITEM #	LEDS	LENS	PACKAGE	PACK
36893	16 Amber	Amber	Carded	1 Pc./Card
36894	16 Red	Red	Carded	1 Pc./Card
36895	16 Amber	Clear	Carded	1 Pc./Card
36896	16 Red	Clear	Carded	1 Pc./Card



NEW!

1 SMD LED MINI CLEARANCE/MARKER LIGHT

COMPETITION SERIES

- 1 SMD LED Mini Clearance/Marker Light with Rubber Grommet
- Require 3/4" Diameter Hole for Installation
- Available in Amber or Red LED with Colored Lens, **Lifetime Warranty**

ITEM #	LEDS	LENS	PACKAGE	PACK
36843	1 Amber	Amber	Carded	1 Pc./Card
36844	1 Red	Red	Carded	1 Pc./Card



Dual Function

10 LED DUAL FUNCTION DOUBLE FACE REFLECTOR LIGHT - T MOUNT

- 10 LED Rectangular Dual Function Double Face Light
- Chrome Die Cast T-Mount Housing Available Separately: Item # 30962B
- For Auxiliary/Utility Light Applications, 3 Wires Hard Wired

ITEM #	LEDS	LENS	BEZEL	PACK
36411	10 Amber/ 10 Red	Amber/ Red	Horizontal Visor	1 Pc./Card
36412	10 Amber/ 10 Red	Amber/ Red	Vertical Visor	1 Pc./Card
36413	10 Amber/ 10 Red	Amber/ Red	Flat	1 Pc./Card
36414	10 Amber/ 10 Red	Amber/ Red	No	1 Pc./Card
36415	10 Amber/ 10 Red	Clear/ Clear	Horizontal Visor	1 Pc./Card
36416	10 Amber/ 10 Red	Clear/ Clear	Vertical Visor	1 Pc./Card
36417	10 Amber/ 10 Red	Clear/ Clear	Flat	1 Pc./Card
36418	10 Amber/ 10 Red	Clear/ Clear	No	1 Pc./Card



Dual Function

10 LED DUAL FUNCTION DOUBLE FACE REFLECTOR LIGHT - STRAIGHT

- 10 LED Rectangular Dual Function Double Face Light
- Chrome Die Cast Straight Housing Available Separately: Item # 30963B
- For Auxiliary/Utility Light Applications, 3 Wires Hard Wired

ITEM #	LEDS	LENS	BEZEL	PACK
36419	10 Amber/ 10 Red	Amber/ Red	Horizontal Visor	1 Pc./Card
36420	10 Amber/ 10 Red	Amber/ Red	Vertical Visor	1 Pc./Card
36421	10 Amber/ 10 Red	Amber/ Red	Flat	1 Pc./Card
36422	10 Amber/ 10 Red	Amber/ Red	No	1 Pc./Card
36423	10 Amber/ 10 Red	Clear/ Clear	Horizontal Visor	1 Pc./Card
36424	10 Amber/ 10 Red	Clear/ Clear	Vertical Visor	1 Pc./Card
36425	10 Amber/ 10 Red	Clear/ Clear	Flat	1 Pc./Card
36426	10 Amber/ 10 Red	Clear/ Clear	No	1 Pc./Card

10 LED DUAL FUNCTION RECTANGULAR LIGHT - REFLECTOR

- 10 LED Dual Function Small Rectangular Clearance/Marker Light with Reflector
- Unique Reflector Design Projects Light in Multiple Directions
- 3 Wires Hard Wire, **Lifetime Warranty**

ITEM #	LEDS	LENS	PACKAGE	PACK
36551B	10 Amber	Amber	Bulk	1 Pc.
36552B	10 Red	Red	Bulk	1 Pc.
36553B	10 Amber	Clear	Bulk	1 Pc.
36554B	10 Red	Clear	Bulk	1 Pc.

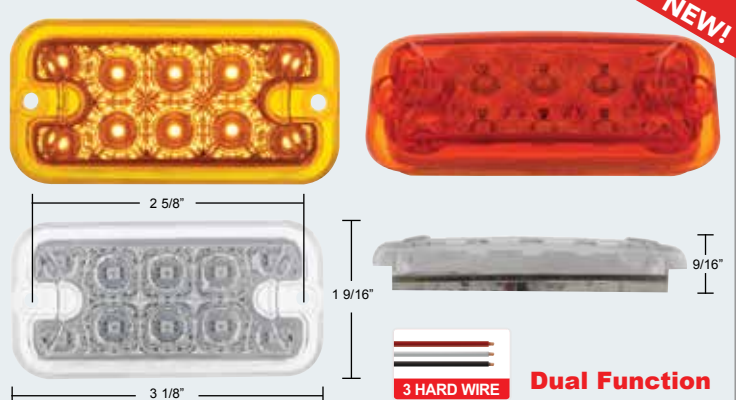



NEW!

FREIGHTLINER CASCADIA DUAL GAUGE COVER WITH VISOR

- Chrome Plastic Dual Speed and Tachometer Gauge Cover
- Fits Freightliner Cascadia and Various 2007+ Freightliner Truck

ITEM #	DESCRIPTION	PACKAGE	PACK
42330	Dual Gauge Cover	Carded	1 Pc./Card



NEW!

FREIGHTLINER CORONADO/CASCADIA/M2 DUAL GAUGE DIAMOND PEDAL SET

- Fits Various Freightliner Models and Years
- CNC Machined Diamond Design, Ultra High Quality Finish

ITEM #	DESCRIPTION	PACKAGE	PACK
70361	Diamond Pedal Set	Color Box	1 Set/Box



NEW!

2005+ PETERBILT 379/386/389 5" CHOPPED WINDOW TRIM

- Stainless Steel Peterbilt 5" Chopped Window Trim
- Fits 2005+ Peterbilt 379/386/389 and Various Other Peterbilt Models with Cab Mounted Mirrors

ITEM #	DESCRIPTION	PACKAGE	PACK
29095	5" Chopped Window Trim	Color Box	1 Pair/Box



NEW!

CHROME EXTERIOR ANTENNA COVER

- Chrome Plastic Exterior Antenna Cover
- Fits Various Peterbilt and Freightliner Cascadia
- Easy Installation, Snaps onto Existing OEM Antenna Mounting Base

ITEM #	DESCRIPTION	PACKAGE	PACK
42779	Antenna Cover	Carded	1 Pc./Card



NEW!

42222

42223

INTERNATIONAL 4000/7000/9000 WINDOW REGULATOR

- Window Regular for International Trucks
- Sold Individually, Please Specify Driver or Passenger Side

ITEM #	APPLICATION	OEM NUMBER	PACKAGE	PACK
42222	Driver	1686704C91	Bulk	1 Pc.
42223	Passenger	1686705C91	Bulk	1 Pc.



NEW!

Thread Size
5/16"-18TPI

2 5/8"

6 1/2"

CHROME 3 EXTRA LARGE STRAIGHT BAR SPINNER

- Chrome Plastic Spinner for Hub Cap
- 3 Extra Large Bar Straight Swing

ITEM #	DESCRIPTION	PACKAGE	PACK
10722	3 XL Bar Spinner	Carded	1 Pc./Card
10722B	3 XL Bar Spinner	Bulk	1 Pc.



NEW!

7 11/16"

50 CALIBER BULLET 13/15/18 SPEED SHIFT KNOB

- 50 Caliber Bullet Shift Knob for 13/15/18 Speed Gearshift Knob
- 13/15/18 Mounting Adapter: Item # 70603B, and Bullet Knob: Item # 70674, Available Separately

ITEM #	DESCRIPTION	PACKAGE	PACK
70590	13/15/18 Bullet Shift Knob	Carded	1 Pc./Card



NEW!

6 1/2"

1 1/8"

Mounting Hardware

50 CALIBER BULLET SHIFT KNOB

- 50 Caliber Bullet Style Shift Knob
- Ultra High Quality Aluminum Alloy and Bronze Finish
- Universal Hex Screw Mount Design

ITEM #	DESCRIPTION	PACKAGE	PACK
70674	Bullet Shift Knob	Carded	1 Pc./Card

Australian Truck Products

NEW!



KENWORTH CHROME ROCKER SWITCH TRIM

- Chrome Plastic Switch for Kenworth
- Fits Various Australian Kenworth Model



ITEM #	DESCRIPTION	PACKAGE	PACK
41442	Rocker Switch Trim	Carded	3 Pcs./Card

Australian Truck Products

NEW!



33 mm NUT COVER WITH FLANGE - PUSH-ON FOR AUSTRALIAN VOLVO

- Chrome Plastic 33 mm Push-On Slotted Nut Cover for Australian Volvo

ITEM #	SIZE	HEIGHT	FLANGE	PACK
10281B	33 mm	2 3/4"	Yes	Bulk = 1 Pc.



UPI COOLER BAG

- Insulated Cooler Bag Keeps Food and Beverages Cold
- Adjustable Shoulder Strap

ITEM #	DESCRIPTION	PACKAGE	PACK
99089	UPI Cooler Bag	Bulk	1 Pc.



UPI WATER BOTTLE

- Lightweight 25 oz. Aluminum Bottle With Carabiner Clip for Easy Carrying
- Topper Seals Tightly-Features a Black Leak-Proof Screw-Down Lid

ITEM #	DESCRIPTION	PACKAGE	PACK
99090	UPI Water Bottle	Bulk	1 Pc.



NEW!



**1933-36 FORD
LED TAIL LIGHT - SMOKE LENS**

- 21 Super Bright Red LED Tail Light with Smoke Lens for 1933-36 Ford
- Driver Side Includes a 4 White LED License Light
- Epoxy Coated, Fully Sealed Electronics, 1157 Plug
- Solid State Circuit Boards are Designed for 7.7 - 14.0 VDC

1157 PLUG

ITEM #	LEDS	LENS	APPLICATION	PACK
110150	21 Red 4 White	Smoke	Driver License	1 Pc./Card

Custom Motorcycle Products

NEW!



**LED
MOTORCYCLE REAR FENDER TAIL LIGHT**

- "Bobber" Style LED 1933-36 Ford Tail Light with Smoke Lens and LED License Light
- Motorcycle Rear Fender Tail Light / License Light
- Available with Chrome Mounting Bracket: Item # 20646, or Black Mounting Bracket: Item # 20647
- Smoke Lens LED Tail Light Available Separately: Item # 110150

ITEM #	LEDS	LENS	BRACKET	PACK
20216	21 Red 4 White	Smoke	Chrome	1 Pc./Box
20217	21 Red 4 White	Smoke	Black	1 Pc./Box

Custom Motorcycle Products

NEW!



**LED
"BOBBER" STYLE HORIZONTAL TAIL LIGHT**

- "Bobber" Style LED 1933-36 Ford Tail Light with Smoke Lens and LED License Light
- Side Mount Tail Light / License Light
- Available with Chrome Mounting Bracket: Item # 20648, or Black Mounting Bracket: Item # 20619
- Smoke Lens LED Tail Light Available Separately: Item # 110150

ITEM #	LEDS	LENS	BRACKET	PACK
20218	21 Red 4 White	Smoke	Chrome	1 Pc./Box
20219	21 Red 4 White	Smoke	Black	1 Pc./Box

Custom Motorcycle Products

NEW!



**LED
"BOBBER" STYLE VERTICAL TAIL LIGHT**

- "Bobber" Style LED 1933-36 Ford Tail Light with Smoke Lens and LED License Light
- Side Mount Tail Light / License Light
- Available with Chrome Mounting Bracket: Item # 20649, or Black Mounting Bracket: Item # 20620
- Smoke Lens LED Tail Light Available Separately: Item # 110150

ITEM #	LEDS	LENS	BRACKET	PACK
20220	21 Red 4 White	Smoke	Chrome	1 Pc./Box
20221	21 Red 4 White	Smoke	Black	1 Pc./Box

UN160825

OCTOBER 2016 WHAT'S NEW



**304
Stainless**

STAINLESS PETERBILT 359 LED HEADLIGHT

- 304 Stainless Steel Peterbilt 359 Style LED Headlight
- Light Weight & Less Maintenance than Aluminum Housing
- Give your Truck the Classic 359 Look
- Available with 5 3/4" LED Headlight with Amber LED Position Light Bar (Item # 31259) or White LED Position Light Bar (Item # 31267)

ITEM #	APPLICATION	DESCRIPTION	PACK
32142	Driver	Amber LED Light Bar	1 Pc./Box
32141	Passenger	Amber LED Light Bar	1 Pc./Box
32143	Driver	White LED Light Bar	1 Pc./Box
32144	Passenger	White LED Light Bar	1 Pc./Box

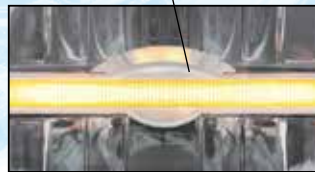

**AMBER LED Position
Light Bar**

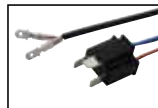

5 3/4" LED HEADLIGHT WITH LED POSITION LIGHT BAR

- 9 High Power LED Headlight with LED Position Light Bar
- Reinforced Aluminum Reflector, Rugged Anti-Vibration Construction
- Available with Amber or White LED Light Bar
- DOT/SAE: HL P 15

ITEM #	DESCRIPTION	PACKAGE	PACK
31259	Amber LED Light Bar	Color Box	1 Pc./Box
31267	White LED Light Bar	Color Box	1 Pc./Box

NEW!



NEW!



**OEM
Plug**

11 LED "GLO" CAB LIGHT FOR PETERBILT 579 & KENWORTH T680

GloLight™

- 11 LED "GLO" Cab Light with OEM Plug for Peterbilt 579 and Kenworth T680
- Also Fits Other Peterbilt and Kenworth Models and Years
- Available in Amber or Clear Lens, **Lifetime Warranty**

ITEM #	LEDS	LENS	PACKAGE	PACK
36891	11 Amber	Amber	Carded	1 Pc./Card
36892	11 Amber	Clear	Carded	1 Pc./Card



LIGHT
1080
LUMENS

MULTIPLE
10V - 30V
VOLTAGE

HIGH POWER
278 WATT X 9
LED

COMPETITION
SERIES

9 HIGH POWER LED SQUARE WORK LIGHT - COMPETITION SERIES

- 9 High Power LED Square Work Light, Competition Series
- 10V-30V, 1080 Lumens, **3 Years Warranty**

ITEM #	LEDS	FUNCTION	IP RATING	PACK
36618	25 Watt	Flood	67	1 Pc./Box



10 LED 9\"/>



- 10 LED 9\"/>
- Mounting Hole Approximately 8 1/2\"/>

ITEM #	LEDS	LENS	PACKAGE	PACK
38005	10 White	Clear	Card	1 Pc./Card
38005B	10 White	Clear	Bulk	1 Pc.



KENWORTH T660 HEADLIGHT ASSEMBLY

- Headlight Assembly for 2008 and Newer Kenworth T660 Trucks
- Sold Individually, Please Specify Driver or Passenger Side

ITEM #	APPLICATION	OEM NUMBER	PACK
31293	Driver	P54-1059-100	1 Pc./Box
31294	Passenger	P54-1059-100R	1 Pc./Box



7\"/>

- Complete Assembly, Available in Stainless, Chrome, and Black Finished
- Crystal Headlight Bulb with Amber Hi/Low Function LEDs
- DOT/SAE: HR 15, LEDs for Auxiliary/Utility Purposes
- Crystal Headlight with 6 Amber Auxiliary LED Available Separately: Item # 31247
- Headlight Housing Available Separately: Item # 32006 (Stainless)/32008 (Chrome)/32009 (Black)
- 12V, Dual Function Auxiliary LEDs Have Three Wire Hookup

ITEM #	DESCRIPTION	FINISH	PACK
32557	7\"/>	Stainless	1 Pc./Box
32558	7\"/>	Chrome	1 Pc./Box
32559	7\"/>	Black	1 Pc./Box



304
Stainless

STAINLESS "TRIPLE EMBOSSED STRIPE" PETERBILT HEADLIGHT HOUSING WITH 4 AMBER LED TURN SIGNAL

- 304 Stainless Stripe Peterbilt Headlight Housing
- Available with Classic Style Rim or Bullet Style Rim
- Signal Light Lens Available with Amber or Clear Lens

ITEM #	RIM STYLE	SIGNAL LENS COLOR	PACKAGE	PACK
32724	Classic	Amber	Boxed	1 Pc./Box
32725	Classic	Clear	Boxed	1 Pc./Box
32726	Bullet	Amber	Boxed	1 Pc./Box
32727	Bullet	Clear	Boxed	1 Pc./Box



304
Stainless

STAINLESS "TRIPLE EMBOSSED STRIPE" PETERBILT HEADLIGHT HOUSING WITHOUT RIM

- 304 Stainless Stripe Peterbilt Headlight Housing without Rim

ITEM #	DESCRIPTION	PACKAGE	PACK
30374	7" Classic Headlight	Boxed	1 Pc./Box



304
Stainless

STAINLESS "TRIPLE EMBOSSED STRIPE" PETERBILT HEADLIGHT HOUSING WITHOUT TURN SIGNAL

- 304 Stainless Stripe Peterbilt Headlight Housing
- Available with Classic Style Rim or Bullet Style Rim

ITEM #	DESCRIPTION	PACKAGE	PACK
32728	Classic Style Housing	Boxed	1 Pc./Box
32729	Bullet Style Housing	Boxed	1 Pc./Box



1 1/2" x 2 3/4" SLOTTED BULLET PUSH-ON NUT COVER - WITH FLANGE

- Chrome Plastic Bullet Push-On Nut Cover for Axle Covers

ITEM #	DESCRIPTION	PACKAGE	PACK
10046B	Slotted Bullet Nut Cover	Bulk	500/Case
10046	Slotted Bullet Nut Cover	Carded	20 Pcs./Card

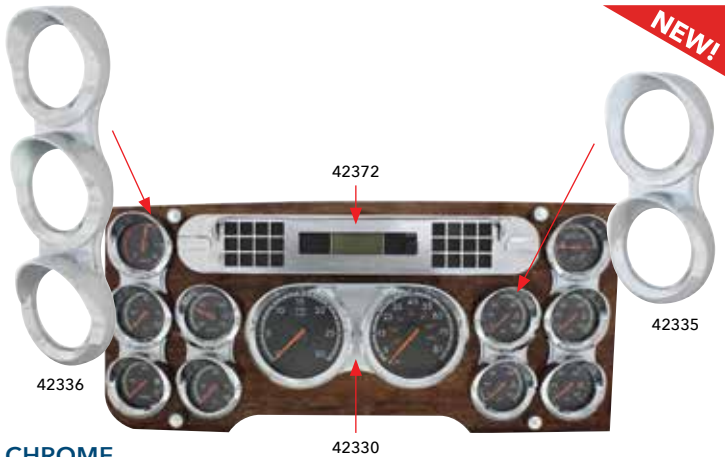

CHROME 2007+ FREIGHTLINER CASCADIA SMALL GAUGE CLUSTER COVERS - VERTICAL

- Chrome Plastic Vertical Gauge Cover with Visor for 2007+ Freightliner Cascadia
- Available in 2 and 3 Gauge Clusters

ITEM #	DESCRIPTION	PACKAGE	PACK
42335	Dual Small Gauge Cover/Vertical	Carded	1 Pc./Card
42336	Triple Small Gauge Cover/Vertical	Carded	1 Pc./Card
42372	Message Center Cover	Carded	1 Pc./Card
42330	Speedo & Tach Cover	Carded	1 Pc./Card



CHROME 2007+ FREIGHTLINER CASCADIA SMALL GAUGE CLUSTER COVERS - HORIZONTAL

- Chrome Plastic Horizontal Gauge Cover with Visor for 2007+ Freightliner Cascadia
- Available in Single and 2 Gauge Clusters

ITEM #	DESCRIPTION	PACKAGE	PACK
42333	Single Small Gauge Cover	Carded	1 Pc./Card
42334	Dual Small Gauge Cover/Horizontal	Carded	1 Pc./Card
42372	Message Center Cover	Carded	1 Pc./Card
42330	Speedo & Tach Cover	Carded	1 Pc./Card

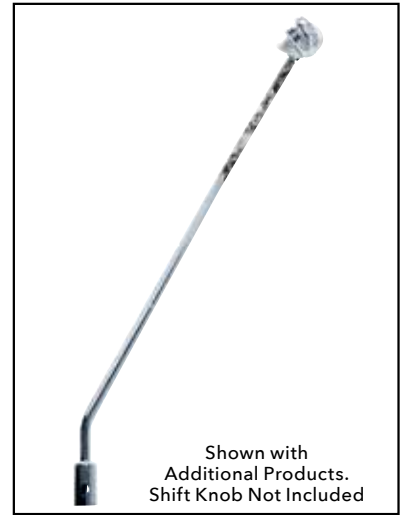

12" SKULL SHIFTER SHAFT EXTENDER

- 12" Skull Shifter Shaft Extender
- Thread On (1/2" - 13 UNC Thread), Thread 1" Long, Fits Shifter Shaft: Item # 21740
- 3/4" Diameter Thickness
- For Off-Road and Show Use Only

ITEM #	DESCRIPTION	PACKAGE	PACK
21798	Skull Shifter Shaft	Carded	1 Pc./Card

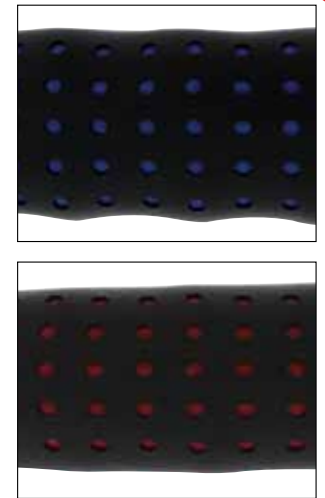

18" LEATHER STEERING WHEEL COVER

- Perforated 18" Black Leather Steering Wheel Cover
- Available with Blue or Red Color
- Perforations Make Wheel Easier to Grip

ITEM #	DESCRIPTION	PACKAGE	PACK
70135	Blue Perforated	Carded	1 Pc./Card
70136	Red Perforated	Carded	1 Pc./Card

NOVEMBER 2016 WHAT'S NEW



MIRAGE DOUBLE VISION LED LIGHT

24 LED 4" S/T/T & P/T/C Light - "Mirage"

DESCRIPTION

- 24 LED 4" S/T/T & P/T/C "Mirage" Light
- 3 Contact Female Plug, Available in Color or Clear Lens
- DOT/SAE Approved
- Recommended Plug: Item # 34212/34216, [Lifetime Warranty](#)

Item #	LEDs	Lens	Package	Pack
36652	Red	Red	Carded	1 Pc./Card
36653	Amber	Amber	Carded	1 Pc./Card
36654	Red	Clear	Carded	1 Pc./Card
36655	Amber	Clear	Carded	1 Pc./Card

24 LED 6" Oval S/T/T & P/T/C Light - "Mirage"



DESCRIPTION

- 24 LED 6" Oval S/T/T & P/T/C "Mirage" Light
- 3 Contact Female Plug, Available in Color or Clear Lens
- DOT/SAE Approved
- Recommended Plug: Item # 34212/34216, [Lifetime Warranty](#)

Item #	LEDs	Lens	Package	Pack
36656	Red	Red	Carded	1 Pc./Card
36657	Amber	Amber	Carded	1 Pc./Card
36664	Red	Clear	Carded	1 Pc./Card
36665	Amber	Clear	Carded	1 Pc./Card



24 LED Back-Up Light - "Mirage"



DESCRIPTION

- 24 Super White LED Back-Up "Mirage" Light
- 3 Contact Female Plug, Available in 4" Round or 6" Oval
- DOT/SAE Approved
- Recommended Plug: Item # 34215, [Lifetime Warranty](#)

Item #	Description	Package	Pack
36836	4" Round Back-Up Light	Carded	1 Pc./Card
36837	6" Oval Back-Up Light	Carded	1 Pc./Card



2007+ FREIGHTLINER WITH 72 SPLINES PERFECT FOR 2007+ CASCADIA

NEW!



Chrome Freightliner Steering Hub

DESCRIPTION

- 72 Splines, Fits Various 2007+ Freightliner Models
- Chrome Diecast Freightliner Steering Hub for United Pacific Steering Wheels
- Mix and Match with United Pacific Steering Wheels and Designer Horn Bezel for a Unique Look

Item #	Description	Package	Pack
88238	Freightliner Steering Hub	Color Box	1 Pc./Box

18" WHEEL RIM STEERING WHEEL WITH CHROME SPOKE



88217



88218



88219



88220



88221



88222

CHROME STEERING/HORN BUTTON BEZEL



88216



88223

CHROME STEERING WHEEL HORN BUTTON



88120

30 LED 4" Round S/T/T Light - Competition Series

NEW!

DESCRIPTION

- 30 LED 4" Round S/T/T Light
- 3 Contact Female Plug. DOT/SAE Approved
- Recommended Plug: Item # 34212/34216. *Lifetime Warranty*

Item #	LEDs	Lens	Package	Pack
36832	Red	Red	Carded	1 Pc./Card



COMPETITION
SERIES



9 High Power LED 4" x 6" Rectangular Light with LED Light Bar



DESCRIPTION

- 9 High Power LED Dual Function Light with 6 White LED Light Bar
- Die Cast Housing Provides Maximum Protection from the Elements
- Headlight Fits OEM Housing, Plugs into Existing Wiring Harness
- For Off-Road Use Only, **3 Years Warranty**

Item #	Description	Package	Pack
34125	9 LED Rectangular Light	Color Box	1 Pc./Box

Technical Specification

Low Beam Application

10 - 30V DC Input
1.17 Amps / 35 Watt
1,600 Lumens

High Beam Application

10 - 30V DC Input
1.17 Amps / 35 Watt
3,000 Lumens



COMPETITION
SERIES

15 High Power LED 4" x 6" Rectangular Light



DESCRIPTION

- 15 High Power 3 Watt LED Dual Function Rectangular Light
- Die Cast Housing Provides Maximum Protection from the Elements
- Headlight Fits OEM Housing, Plugs into Existing Wiring Harness
- For Off-Road Use Only, **3 Years Warranty**

Item #	Description	Package	Pack
34124	15 LED Rectangular Light	Color Box	1 Pc./Box

Technical Specification

Low Beam Application

10 - 30V DC Input
1.5 Amps / 45 Watt
1,100 Lumens

High Beam Application

10 - 30V DC Input
1.5 Amps / 45 Watt
2,000 Lumens



COMPETITION
SERIES

15 High Power LED 4" x 6" Rectangular Projection Light



DESCRIPTION

- 15 High Power 3 Watt LED Dual Function Projection Light
- Die Cast Housing Provides Maximum Protection from the Elements
- Headlight Fits OEM Housing, Plugs into Existing Wiring Harness
- For Off-Road Use Only, **3 Years Warranty**

Item #	Description	Package	Pack
34123	15 LED Rectangular Light	Color Box	1 Pc./Box

Technical Specification

Low Beam Application

10 - 30V DC Input
1.5 Amps / 45 Watt
1,100 Lumens

High Beam Application

10 - 30V DC Input
1.5 Amps / 45 Watt
2,000 Lumens



COMPETITION
SERIES

9 High Power LED Work Light



DESCRIPTION

- 9 High Power 3 Watt LED Round Work Light, Competition Series
- 10V-30V Application, 1400 Lumens, **3 Years Warranty**

Item #	Description	Package	Pack
36617	9 LED Work Light	Color Box	1 Pc./Box



LIGHT **MULTIPLE** **HIGH POWER**
1400 **10V - 30V** **2.78 WATT X 9**
LUMENS **VOLTAGE** **LED**

COMPETITION
SERIES

STAINLESS STEEL CLASSIC EMBOSSED STRIPE

NEW!



Stainless "Classic" Embossed Stripe Peterbilt Headlight

DESCRIPTION

- Stainless Steel Embossed Stripe Peterbilt Headlight with "Classic" Headlight Bezel
- Available with 4 Amber LED Dual Function Turn Signal in Amber or Clear Lens and 7 Different Bulbs
- Sold: Boxed = 1 Kit/Box

LED Headlight

Item #	Housing	Rim	Signal Light	Signal Lens	LED Bulb Type
32730	30374	30399	4 Amber LED	Amber	5 LED 7" Round (31391)
32731	30374	30399	4 Amber LED	Clear	5 LED 7" Round (31391)
32732	30374	30399	4 Amber LED	Amber	11 LED Crystal 7" Round (31355)
32733	30374	30399	4 Amber LED	Clear	11 LED Crystal 7" Round (31355)

Incandescent Headlight

Item #	Housing	Rim	Signal Light	Signal Lens	Incandescent Bulb Type
32734	30374	30399	4 Amber LED	Amber	6014 Seal Beam (30354)
32735	30374	30399	4 Amber LED	Clear	6014 Seal Beam (30354)
32736	30374	30399	4 Amber LED	Amber	H6024 Halogen (30356)
32737	30374	30399	4 Amber LED	Clear	H6024 Halogen (30356)
32738	30374	30399	4 Amber LED	Amber	34 Amber LED Crystal Halogen (31378)
32739	30374	30399	4 Amber LED	Clear	34 Amber LED Crystal Halogen (31378)
32740	30374	30399	4 Amber LED	Amber	34 White LED Crystal Halogen (31379)
32741	30374	30399	4 Amber LED	Clear	34 White LED Crystal Halogen (31379)
32742	30374	30399	4 Amber LED	Amber	Crystal H4 Halogen (31387)
32743	30374	30399	4 Amber LED	Clear	Crystal H4 Halogen (31387)



STAINLESS STEEL BULLET EMBOSSED STRIPE

NEW!



Stainless "Bullet" Embossed Stripe Peterbilt Headlight

DESCRIPTION

- Stainless Steel Embossed Stripe Peterbilt Headlight with "Bullet" Headlight Bezel
- Available with 4 Amber LED Dual Function Turn Signal in Amber or Clear Lens and 7 Different Bulbs
- Sold: Boxed = 1 Kit/Box

LED Headlight

Item #	Housing	Rim	Signal Light	Signal Lens	LED Bulb Type
32746	30374	30416	4 Amber LED	Amber	5 LED 7" Round (31391)
32747	30374	30416	4 Amber LED	Clear	5 LED 7" Round (31391)
32748	30374	30416	4 Amber LED	Amber	11 LED Crystal 7" Round (31355)
32749	30374	30416	4 Amber LED	Clear	11 LED Crystal 7" Round (31355)



Incandescent Headlight

Item #	Housing	Rim	Signal Light	Signal Lens	Incandescent Bulb Type
32750	30374	30416	4 Amber LED	Amber	6014 Seal Beam (30354)
32751	30374	30416	4 Amber LED	Clear	6014 Seal Beam (30354)
32752	30374	30416	4 Amber LED	Amber	H6024 Halogen (30356)
32753	30374	30416	4 Amber LED	Clear	H6024 Halogen (30356)
32754	30374	30416	4 Amber LED	Amber	34 Amber LED Crystal Halogen (31378)
32755	30374	30416	4 Amber LED	Clear	34 Amber LED Crystal Halogen (31378)
32756	30374	30416	4 Amber LED	Amber	34 White LED Crystal Halogen (31379)
32757	30374	30416	4 Amber LED	Clear	34 White LED Crystal Halogen (31379)
32758	30374	30416	4 Amber LED	Amber	Crystal H4 Halogen (31387)
32759	30374	30416	4 Amber LED	Clear	Crystal H4 Halogen (31387)





Stainless Peterbilt Front Air Cleaner Bracket - 22 Mini LED Clearance/Marker Lights

DESCRIPTION

- Stainless Steel Peterbilt Front Air Cleaner Bracket with 22 Mini LED Clearance/Marker Lights
- 22 Mini LED Light Available in Single or Dual Function



Item #	LEDs	Lens	Function	LED Light		LED Item Number
				Image 1	Image 2	
34462	3 LED	Amber	Dual			36869 x 22
34463	2 LED	Amber	Single			37142 x 22
34464	2 LED	Clear	Single			37144 x 22
34465	3 LED	Amber	Dual			37967 x 22
34466	3 LED	Clear	Dual			37969 x 22
34467	3 LED	Amber	Single			39932 x 22
34468	3 LED	Clear	Single			39934 x 22
34469	3 LED	Amber	Single			36897 x 22
34470	3 LED	Clear	Single			36905 x 22



30069

Stainless Peterbilt Air Cleaner Bracket - 22 Mini Light Cutouts

DESCRIPTION

- Stainless Steel Peterbilt Air Cleaner Light Bracket
- Each Air Cleaner Has Eleven 13/16" Light Cutouts (Total Twenty Two 13/16" Light Cutouts)
- Stainless Steel Bracket Only

Item #	Cutouts	Material	Fit	Pack
30069	11 x 2	Stainless	L & R	1 Pair

NEW!

Stainless Peterbilt Front Air Cleaner Bracket - 26 Mini LED Clearance/Marker Lights

DESCRIPTION

- Stainless Steel Peterbilt Front Air Cleaner Bracket with 26 Mini LED Clearance/Marker Lights
- 26 Mini LED Light Available in Single or Dual Function



Item #	LEDs	Lens	LED Light		LED Item Number
			Function	Image	
34471	3 LED	Amber	Dual		36869 x 26
34472	2 LED	Amber	Single		37142 x 26
34473	2 LED	Clear	Single		37144 x 26
34474	3 LED	Amber	Dual		37967 x 26
34475	3 LED	Clear	Dual		37969 x 26
34476	3 LED	Amber	Single		39932 x 26
34477	3 LED	Clear	Single		39934 x 26
34478	3 LED	Amber	Single		36897 x 26
34479	3 LED	Clear	Single		36905 x 26



30104

Stainless Peterbilt Air Cleaner Bracket - 26 Mini Light Cutouts

DESCRIPTION

- Stainless Steel Peterbilt Air Cleaner Light Bracket
- Each Air Cleaner Has Thirteen 13/16" Light Cutouts (Total Twenty Six 13/16" Light Cutouts)
- Stainless Steel Bracket Only

Item #	Cutouts	Material	Fit	Pack
30104	13 x 2	Stainless	L & R	1 Pair

"Daytona" Spike Gearshift Knob with Adaptor - Horizontal

DESCRIPTION

- "Daytona" Spike Gearshift Knob, Horizontal Mount, CNC-Machined Grip
- Fits 13/18 Speed Gearshift Knobs
- Mounting Adaptor Available Separately: Item # 70600B
- Available in Black and Chrome Finish

Item #	Description	Finish	Pack
70588	"Daytona" Gearshift Knob	Black	1 Pc./Box
70607	"Daytona" Gearshift Knob	Chrome	1 Pc./Box



NEW!

"Daytona" Spike Gearshift Knob - Single Stick Shifter

DESCRIPTION

- "Daytona" Spike Shift Knob, Vertical Mount, CNC-Machined Grip
- Designed for Custom Modification of Modern Single Stick Shifter to Old School Dual Stick Shift System
- Mounting Adaptor Available Separately: Item # 70625B
- Available in Black and Chrome Finish

Item #	Description	Finish	Pack
70586	"Daytona" Gearshift Knob	Black	Bulk = 1 Pc.
70632	"Daytona" Gearshift Knob	Chrome	Bulk = 1 Pc.



NEW!

"Daytona" Spike Gearshift Knob with Adaptor - Vertical

DESCRIPTION

- "Daytona" Spike Gearshift Knob, Vertical Mount, CNC-Machined Grip
- Fits 13/18 Speed Gearshift Knobs
- Mounting Adaptor Available Separately: Item # 70604B
- Available in Black and Chrome Finish

Item #	Description	Finish	Pack
70587	"Daytona" Gearshift Knob	Black	1 Pc./Card
70609	"Daytona" Gearshift Knob	Chrome	1 Pc./Card



New Retail Packaging!

NEW!

"Daytona" Spike Gearshift Knob - Passenger/Pick-Up Vehicle

DESCRIPTION

- "Daytona" Spike Shift Knob, Vertical Mount, CNC-Machined Grip
- Universal 5/16-24 SAE Thread
- Mounting Adaptor Available Separately: Item # 70635B
- Perfect for Passenger Vehicles and Pick-Ups
- Available in Black and Chrome Finish

Item #	Description	Finish	Pack
70585	"Daytona" Gearshift Knob	Black	Bulk = 1 Pc.
70639	"Daytona" Gearshift Knob	Chrome	Bulk = 1 Pc.



NEW!

"Daytona" Spike Air Valve Knob

NEW!

DESCRIPTION

- "Daytona" Spike Air Valve Knob, CNC-Machined Grip
- Mounting Adaptor Available Separately: Item # 23008B
- Available in Black and Chrome Finish

Item #	Description	Finish	Pack
23016	"Daytona" Air Valve Knob	Black	1 Pc./Card
23066	"Daytona" Air Valve Knob	Chrome	1 Pc./Card



"Daytona" Spike Air Horn Valve Lever

NEW!

DESCRIPTION

- "Daytona" Spike Air Horn Valve Lever, CNC-Machined Grip
- Manual Air Horn Valve Lever for Train Horns
- Available in Black and Chrome Finish

Item #	Description	Finish	Pack
45974	"Daytona" Air Horn Valve	Black	1 Set/Box
45993	"Daytona" Air Horn Valve	Chrome	1 Set/Box



"Daytona" Spike Hood Ornament

NEW!

DESCRIPTION

- "Daytona" Spike Hood Ornament, CNC-Machined Grip
- Approximately 16" Long
- Available in Black and Chrome Finish
- Warning: For Ornamental Use Only, Not Intended to be Used as A Hood Handle

Item #	Description	Finish	Pack
72031	"Daytona" Hood Ornament	Black	1 Pc./Box
72026	"Daytona" Hood Ornament	Chrome	1 Pc./Box



"Daytona" Spike Grip

NEW!

DESCRIPTION

- "Daytona" Spike Grip, CNC-Machined Grip
- 1" Round Opening, Hex Screw Mount
- Available in Black and Chrome Finish

Item #	Description	Finish	Pack
70691	"Daytona" Spike Grip	Black	Bulk = 1 Pc.
70601B	"Daytona" Spike Grip	Chrome	Bulk = 1 Pc.



Chrome 2007+ Freightliner Upper Center Trim with Storage Compartment

NEW!

DESCRIPTION

- Chrome Plastic Upper Center Storage Compartment for 2007+ Freightliner
- Fits Freightliner Cascadia and Various Freightliner Models

Item #	Description	Package	Pack
42318	Storage Compartment	Carded	1 Pc./Card



Skull Shifter Shaft Extender

NEW!

DESCRIPTION

- Skull Shifter Shaft Extender
- Thread On (1/2" - 13 UNC Thread), Thread 1" Long
- Fits Shifter Shaft: Item # 21740
- 3/4" Diameter Thickness, Available in 12" and 18"
- For Off-Road and Show Use Only

Item #	Description	Package	Pack
21799	18" Skull Shifter Shaft	Carded	1 Pc./Card
21798	12" Skull Shifter Shaft	Carded	1 Pc./Card



Peterbilt 359 Headlight Bezel

NEW!

DESCRIPTION

- Peterbilt 359 Style Dual Headlight Bezel, Original Style Design
- Available in Stainless Steel and Chrome Plastic

Item #	Description	Finish	Pack
32192B	359 Headlight Bezel	Stainless	Bulk = 1 Pc.
40982	359 Headlight Bezel	Chrome	1 Pc./Card



Diamond Plate License Frame

NEW!

DESCRIPTION

- Zinc Die-Cast Diamond Plate Designer License Frame
- Universal Design, Perfect for Cars, Trucks, and Pickups
- Available in Black and Chrome Finish

Item #	Description	Finish	Pack
50134	Diamond License Frame	Black	1 Pc./Card
50135	Diamond License Frame	Chrome	1 Pc./Card

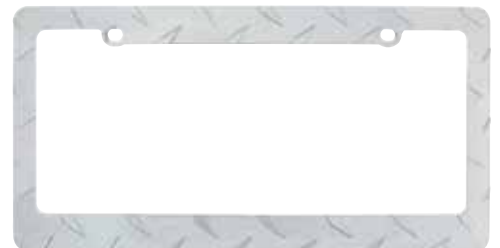

DECEMBER 2016 WHAT'S NEW



**Specially Designed
LED Position Light Bar**



**Available in Chrome
and Blackout Housing**



Unique LED Turn Signal



2008+ Peterbilt 388/389 Projection Headlight with LED Turn Signal and LED Position Light Bar

DESCRIPTION

- Peterbilt 388/389 Projection Headlight with LED Turn Signal and Position Light
- Available in Chrome or Blackout Design
- Sold Individually, Please Specify Driver or Passenger Side
- **1 Year Warranty**

Technical Specification

Low Beam Application

12V DC Input
3.9 Amps / 46.8 Watt
FMVSS 108

High Beam Application

12V DC Input
4.32 Amps / 51.84 Watt
FMVSS 108

Item #	Description	Description	Pack
31243	Driver	Chrome	1 Pc./Box
31244	Passenger	Chrome	1 Pc./Box
31245	Driver	Black	1 Pc./Box
31246	Passenger	Black	1 Pc./Box





NEW!

6" x 4" Rectangular LED Crystal Headlight with 6 Dual Function Amber LED Position Lights

DESCRIPTION

- 6" x 4" Rectangular Crystal Headlights with 1 High Power LED and 6 Dual Function Amber LED Position Lights
- Available in Low Beam or High Beam Modules Only
- Solid State Design Resists Shock and Vibration
- Impact Resistant Polycarbonate Lens Provides Unparalleled Protection from Road Hazards
- Improves Visibility with Whiter Light Output that is Closer to Daylight
- Die-Cast Aluminum Housing Provides Maximum Protection from the Elements
- Load Resistor May be Required for Proper Installation
- SAE/DOT FMVSS108
- For Off-Road Use Only, **3 Years Warranty**

Technical Specification

Low Beam Application

12 - 24V DC Input
0.35 Amps / 8.5 Watt
FMVSS 108

High Beam Application

12 - 24V DC Input
0.6 Amps / 14.5 Watt
FMVSS 108

Item #	Description	Package	Pack
31237	Low Beam	Color Box	1 Pc./Box
31238	High Beam	Color Box	1 Pc./Box

2 High Power LED Work Light

DESCRIPTION

- 2 High Power LED Work Light with Deluxe All Chrome Die-Cast Housing
- 12V-30V, 1200 Lumens, **3 Years Warranty**

NEW!

Item #	LEDs	Function	IP Rating	Pack
36619	5 Watt x 2	Flood	IP67	1 Pc./Card
36620	5 Watt x 2	Spot	IP67	1 Pc./Card



ALL CHROME HOUSING

LIGHT 1200 LUMENS **HIGH POWER 5 WATT X 2 LED** **MULTIPLE 12V - 30V VOLTAGE**

10 LED 9" Dual Function Light Bar

DESCRIPTION

- 10 LED 9" Dual Function Light Bar, 3 Wire Hardwired
- Available with Blue or White LEDs
- Mounting Hole Approximately 8 1/2" Apart, **Lifetime Warranty**

NEW!

Item #	LEDs	Lens	Package	Pack
38004	10 Blue	Clear	Carded	1 Pc./Card
38004B	10 Blue	Clear	Bulk	1 Pc.
38005	10 White	Clear	Carded	1 Pc./Card
38005B	10 White	Clear	Bulk	1 Pc.

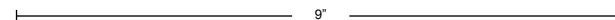

3 HARD WIRE

Chrome Freightliner Columbia Projection Headlight

NEW!

DESCRIPTION

- Chrome Projection Headlight for Freightliner Columbia
- Fits all 1996 and Newer Freightliner Columbia Trucks
- Sold Individually, Please Specify Driver or Passenger Side
- **1 Year Warranty**

Item #	Description	Description	Pack
31346-L	Driver	Projection Headlight	1 Pc./Box
31346-R	Passenger	Projection Headlight	1 Pc./Box



Kenworth Dual Gauge Cover with Visor

NEW!

DESCRIPTION

- Chrome Plastic Dual Speed and Tachometer Gauge Cover for 2006+ Kenworth Truck
- Available with Visor Only

Item #	Description	Visor	Pack
41436	Dual Gauge Cover	Yes	1 Pc./Card



Skull 13/15/18 Speed Shift Knob

NEW!

DESCRIPTION

- Skull Style Shift Knob for 13/15/18 Speed Gearshift Knob
- Zinc Die-Casted, Available in Chrome or Matte Black Finish
- Mounting Adapter: Item # 70603B, Skull Knob: Item # 70681 (Chrome) /70699 (Black) Available Separately
- *Patent Pending*

Item #	Style	Finish	Package	Pack
70709	Skull	Chrome	Carded	1 Pc./Card
70710	Skull	Black	Carded	1 Pc./Card



Skull Shift Knob

NEW!

DESCRIPTION

- Skull Shift Knob
- Zinc Die-Casted, Available in Chrome or Matte Black Finish
- Universal Hex Screw Mount Design, Includes Mounting Hardware

Item #	Style	Finish	Package	Pack
70681	Skull	Chrome	Carded	1 Pc./Card
70699	Skull	Black	Carded	1 Pc./Card



Kenworth Small Gauge Cover with Visor

DESCRIPTION

- Chrome Plastic Small Gauge Cover with Visor
- Fits 2006+ Australian Kenworth Truck

Item #	Description	Package	Pack
41444	Small Gauge Cover	Carded	1 Pc./Card

Australian Truck Products



NEW!

Chrome Shifter Shaft Extension

DESCRIPTION

- Chrome Shifter Shaft Extension
- Thread On (1/2" - 13 UNC Thread), Thread 1" Long
- 3/4" Diameter Thickness, Available in 9" and 18"
- For Off-Road and Show Use Only

Item #	Length	Description	Pack
21792	6"	Shaft Extender	1 Pc./Card
21795	9"	Shaft Extender	1 Pc./Card
21793	12"	Shaft Extender	1 Pc./Card
21794	18"	Shaft Extender	1 Pc./Card

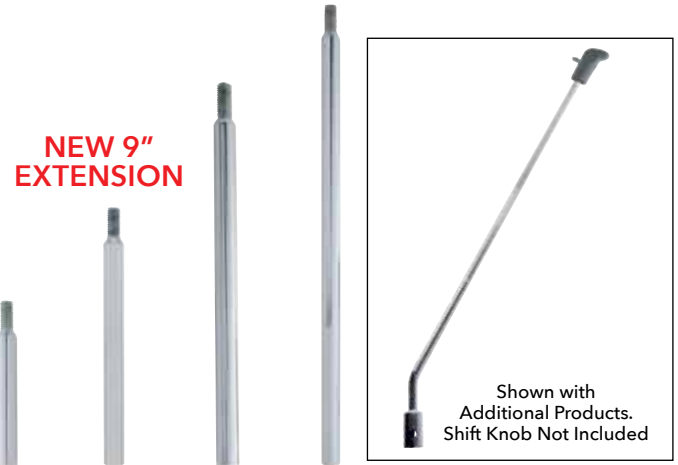

NEW!

Chrome Bezel and Horn Button

DESCRIPTION

- Chrome Aluminum Bezel and Horn Button

Item #	Description	Package	Pack
88261	Bezel & Horn Button	Color Box	1 Pc./Box



NEW!

UPI Counter Mat

DESCRIPTION

- 11" x 17" Heavy Duty Counter Mat
- Non-Skid Backing Eliminates Movement

Item #	Description	Finish	Pack
99007	Counter Mat	Bulk	Bulk = 1 Pc.

NEW!



NEW DESIGN

TERMS & CONDITIONS

IMPORTANT: PLEASE REVIEW CAREFULLY

New Accounts

Initial minimum buy-in is \$5,000 (or to be determined by United Pacific Industries, UPI hereafter). All initial orders must be prepaid in advance by Cashier's Check or VISA/MC. All new/potential accounts must complete a UPI "New Customer Info/Credit Form" and follow the Dealer Qualification Instructions. Upon completion of the credit application, approved accounts will be assigned payment terms of NET 30 Days (from invoice date). Accounts denied a credit line will be required to prepay in advance by Cashier's Check or VISA/MC.

Payment Terms:

Term Accounts

Accounts with NET 30 Days terms are required to submit payment within the 30 days from the date of invoice. Acceptable forms of payment include checks, ACH (Automated Clearing House), or wire transfer.

A service charge of 1.5% per month will be imposed on invoices not paid within the 30 day term. Delinquent accounts will be required to pay Cash-In-Advance (CIA). Checks will be accepted but orders will not be released until the check is cleared by the bank. Past due invoices will delay current orders. Please check with UPI on your account status when placing an order.

Credit Cards

Accounts denied credit terms may pay by Visa or MasterCard. Credit card will be charged upon shipment. Credit card payments will not be accepted once an order has been shipped. UPI does not accept American Express or Discover card. A service fee of 3% will be charged on credit card orders.

COD

A \$12.50 fee will be assessed per COD box for all FedEx/UPS COD shipments. Truck COD shipment fees are to be determined later by trucking company.

Returned Checks:

A \$30 NSF (Non Sufficient Fund) fee will be assessed on each incidence a check is returned to UPI.

ORDERING GUIDELINES

Placing Orders: New orders may be placed by any of the following methods

1. Fax: (888) 986-5988
2. E-mail: sales@upac.com
3. Telephone: In order to minimize errors, customers are encouraged to submit their orders by fax or email. Telephone orders should be limited to smaller orders such as add-ons to orders already submitted and/or fill-ins occurring between larger restocking orders.

Changes to Orders:

Whenever possible, revisions to orders - additions or deletions of items - should also be submitted via fax or email to reduce the possibility of errors.

Additions/Deletion of items will only be accepted within 48 hours after the initial order date and/or before 12:00PM on the date of the shipment. Additions of items placed after the 48 hours time period will be considered a new order and adhere to a new order freight prepaid policy. Deletions of item cannot happen after the 48 hours time period and/or after 12:00PM on the date of the shipment. Please note additions and/or deletions of items will delay the shipment date.

Canceling Orders:

Cancellation of orders must be submitted via fax or email within 24 hours of the order date. If the order has already shipped it will be the customers responsibility to return the order at the customers own expense. A restocking fee may apply, please see "Return" policy for further detail.

Backorders:

Customers have the option of having their backorders shipped or cancelled. Backorders resulting from a freight prepaid qualifying order will be shipped freight prepaid. UPI reserves the right to cancel backorders that are 6 months or older from the initial invoice date.

Minimum Order:

A minimum order of \$50.00 is required. Orders below \$50.00 will be assessed a minimum order fee of \$10.00.

Packaging:

A 10% service charge will be added to orders with special packaging or UPC barcoding requirements.

Lead Times:

Standard lead time for all United Pacific orders is 1-3 business days from the receipt of the purchase order. Larger orders may require a lead time of up to 5 business days. Transit time of 3-5 business days must be considered when placing orders. UPI cannot be responsible for delays in shipment after an order leaves our warehouse. UPI will work to resolve delays with freight

forwarding firms, however, delays do arise from time to time due to weather and unforeseen circumstances beyond UPI's control. Express order are exempted; please view Freight/Shipping Policy for further detail.

Order Confirmation:

United Pacific will acknowledge receipt of orders by email/fax/telephone within 1 business day of receipt. If confirmation is not received, please contact UPI to ensure your order was received.

FREIGHT

Prepaid Freight:

Stock orders between \$50 and \$999.99 (US Lower 48 States), **\$50 and \$2499.99 (Alaska and Hawaii)**, **\$50 and \$1499.99 (Canada)**, [all price net US\$], will be shipped FOB Long Beach, California. Stock orders of \$1,000 (US Lower 48 States), **\$2500 (Alaska and Hawaii)**, **\$1500 (Canada)**, [based on UPI current pricing], or more will be shipped Freight Prepaid Ground to a single location only. (See exception for Oversize Items*). *Express Air orders, Special Net Pricing orders, and Special Quote Pricing orders are excluded.* United Pacific reserves the right to select the carrier of our choice. Customers may select the carrier of their choice at their own expense, negotiated rates and insurance. Special handling charges such as lift gate fee, residential delivery fees are not included in the prepaid freight policy. If customers elect to choose their own freight carrier, orders will be shipped via FREIGHT COLLECT.

***Oversize Freight Policy** – Applies to bumpers, bumper covers, grills, fairings, fenders, and any exceptionally large or heavy item. 2 options:

1. Freight will be prepaid by United Pacific if the total order of all items exceeds **\$4,000 (US Lower 48 States)** or **\$5000 (Hawaii, Alaska and Canada)**, [all price net US\$]. There will not be additional charges for these items included on the order.
2. Freight will be prepaid by United Pacific if a customer orders a total of **\$2,500 (US Lower 48 States)** or **\$3500 (Hawaii, Alaska and Canada)**, [all price net US\$], of bumpers, bumper covers, grills, fairings, fenders, and any exceptionally large or heavy item. If the order is below **\$2,500 (US Lower 48 States)** or **\$3500 (Hawaii, Alaska and Canada)**, United Pacific will add freight charges to the order for the oversize items.

Will Call Orders:

Will Call orders can be picked up 2 - 4 hours after placing the order. Customers should always call ahead to confirm when order will be ready to pick up.

SHIPPING POLICY / CLAIMS

IMPORTANT: PLEASE REVIEW CAREFULLY

SHIPPING POLICY

International Shipments:

Shipments to locations outside the continental United States will be shipped to the customer's shipping agent or broker within the continental United States in accordance with the US freight policy. International customers will be responsible for the duties and taxes of their respective country.

Express Orders:

All express orders, such as Next Day, Second Day, 3 Day Service & Will Call, must be faxed/emailed. Order confirmation will be faxed to the customer for final approval. If confirmation is not received, please contact UPI to ensure your order was received. Customers are required to sign off on express orders and fax confirmation back to UPI. Cut off for express order is 12:00PM. Express orders received after 12:00PM may or may not ship the same day. Please call UPI to confirm projected shipping date or will call time.

Due to the high cost of express shipments, customer may request UPI to call to confirm freight charges. If customer does not request confirmation, UPI will ship the express order.

Drop Shipments:

All drop shipment orders will be assessed a \$10.00 processing fee. Drop shipment processing fee will be automatically added to the invoice without notice. All drop shipment orders must be faxed in. No freight allowance or prepaid freight will be permitted for any drop shipments, thus, all drop ship orders, regardless of order size, are FOB Long Beach, CA.

CLAIMS

General Policy:

All claims (Shortage, Mis-Shipped, Damage, Overage, Customer Error & Billing Error) must be submitted to UPI within 3 business days of the receipt of shipment. Claims submitted beyond 3 business days of the receipt of shipment will be voided by UPI.

On all shipments, the person who signs and receives the shipment is responsible for noting on the Bill of Lading, in writing, whether any boxes arrived damaged or shorted. Failure to do so will void all claim rights between all parties. UPI will have no recourse against the trucking company if customer does not note any damages or shortages on the Bill of Lading.

The customers receiving department must count and sign for the exact number of boxes received. Failure to follow the above instructions will void all claim rights between all parties.

Shortages / Mis-Ships / Damages

While UPI strives to fill every order with 100% accuracy, on occasion an item may get shipped in error or get damaged during shipping. In the event this occurs, please follow the process below. Note: This type of claim must be reported to UPI within three (3) business days of receiving the order.

1. Contact the United Pacific office to initiate the claim. To make it easy for you we have two acceptable methods for requesting the claim:

* By e-mail : returns@uapac.com

* By fax : (888) 986-5988

* **Note: To ensure you receive a timely credit, we cannot accept claim requests by phone.**

2. You will be required to provide the following information:

- * Your business name
- * Contact name and telephone number (in case we have questions)
- * Date the order was received
- * A copy of the Packing List / Invoice noting the item number and quantity that was shipped in error or damaged during shipping.
- * Special instructions you have for us.

3. UPI will send a return label so you can ship the items back.

4. Once we receive the miss-shipped/damaged item(s) a credit will be issued to your account on the next billing cycle.

5. Shortages will be credit to the Customers' account, unless customer would like the shortages replaced.

Overages:

UPI strives to provide our customers with the best customer service and products, in turn we would greatly appreciate any help from customer in notifying UPI of any shipping overages. Customers will be offered the option of retaining the merchandise or returning the merchandise to UPI at UPI's expense. If the items are to be returned, an RMA number and return shipping label will be provided.

Customer Errors:

Any item or quantity ordered in error by the customer may be returned by contacting UPI for a RMA No.

1. To make it easy for you we have two acceptable methods for requesting the RMA:

* By e-mail: returns@uapac.com

* By fax: (888) 986-5988

* **Note: To ensure you receive a timely RMA credit, we cannot accept RMA requests by phone.**

2. You will be required to provide the following information.

- * Your business name
- * Contact name and telephone number (in case we have questions)
- * A list of the items number and quantity ordered in error
- * Special instructions you have for us

3. UPI will review the request to ensure the products are within the return period.

4. Once we have validated the request, United Pacific will issue an RMA number to the customer. In issuing the RMA approval, the following conditions will apply :

- * Returned items are subject to a 20% re-stocking fee.
- * Return shipping costs are the responsibility of the customer.
- * Items must not have any retail/price sticker on exterior packaging or they will be returned to the customer at customer's expense and no credit given.
- * Items must be in good condition with original packaging intact or they will be returned to the customer at customer's expense and no credit given.
- * Allow up to 30 days for the credit to be issued from the time the returned items are received.

Billing Errors:

Billing errors should be reported to UPI within 3 business days of invoice receipt. Customers are asked to provide the invoice number, part number, and quantities in question. Once verified, UPI will issue a credit or an invoice for the difference in billing error.

WARRANTY POLICY / RETURNS

IMPORTANT: PLEASE REVIEW CAREFULLY

WARRANTY POLICY

General Policy:

UPI offers a NO HASSLE WARRANTY RETURN policy to all our customers. Warranty claims can only be submitted through an authorized UPI Distributor. UPI warranty is not transferable and applies to the original installation and purchase only. In no event shall UPI be liable for incidental or consequential damages, nor shall UPI be liable for any claims or damages arising out of or connected with the UPI warranty exceed the purchase price of the products. There are no warranties, expressed or implied (including any warranty of merchantability or fitness) that extend beyond this warranty. The warranty does not apply to costs associated with the loss of use of the product, loss of time, inconvenience, commercial loss, incidental or consequential damages. UPI reserves the right to alter the designs of products without assuming any obligation to modify previously manufactured products and will only replace warranted products with redesigned products.

Warranty does not apply to merchandise that has been drilled, cut, welded, modified in any way or installed contrary to normal installation and usage. In addition, UPI cannot be held liable for damages caused by road hazards, accidents, misuse, neglect, abuse or corrosive environments including acid washes and highway snow/ice chemicals which can cause discoloration and corrosion in aluminum, chrome, stainless steel and light products. UPI reserves the right to credit returned merchandise at the initial purchase price or at the current selling price, which price ever is lower.

Aluminum / Chrome / Stainless Steel Products:

All aluminum, chrome, and stainless steel products carry a limited 6 month warranty (from invoice date) against defects in material or workmanship.

Lighting Products:

Incandescent

All incandescent lighting products carry a limited 12 month warranty (from invoice date) against defects in material or workmanship. The limited 12 month warranty does not apply to several applications, such as, buses, construction equipment, and off road vehicles.

LED

All LED lighting products carry a specific Limited* Warranty (from invoice date) against defects in material or workmanship.

- * LED Marker, 2", 2-1/2", 4", 7", Oval & Square Lights - Varies from 2 years to 10 years to Limited Lifetime, depending on specific item. The housing, bezel or mounting base on any light made from Chrome/Stainless carries a 6 month limited warranty.
- * LED Cab Lights and Kits, Double/Single Stud Turn Signal and PB/KW/FL/VL or non-make Turn Signals and any/all Strip Lights - Varies from 2 years to 10 years to Limited Lifetime, depending on specific item. The housing, bezel or mounting base on any light made from Chrome/Stainless carries a 6 month limited warranty.
- * LED Beacon, Driving, Headlights, Work & Warning Lights - Varies from 6 months to 3 years. The housing, bezel or mounting base on any light made from Chrome/Stainless carries a 6 month limited warranty.
- * All LED Accessory Lights (Honda, Stainless Steel Double/Single face Lights, Interior Lights, License Plate Lights, and any Accent Lights. The housing, bezel or mounting base on any light made from Chrome/Stainless carries a 6 month limited warranty.

RETURNS

General Policy:

All returns must be authorized by UPI. All return requests must be faxed or e-mailed (returns@uapac.com) A RMA number (Return Merchandise Authorization Number) will be provided. Returns not possessing a valid

RMA number are subject to rejection and will be returned to sender at the customer's expense.

All customers are encouraged to use the Warranty RMA Claim Form.

Defective Goods / Warranty Return:

UPI offers our customers a No Hassle Warranty Return. Please follow the instructions below for requesting a RMA for defective goods:

1. If any warranty issues occur, simply contact the UPI for RMA number
To make it easy for you we have two acceptable methods for requesting the RMA:
 - * By e-mail: returns@uapac.com
 - * By fax: (888) 986-5988
 - * **Note: To ensure you receive a timely RMA credit, we cannot accept RMA requests by phone.**
2. You will be required to provide the following information:
 - * Your business name
 - * Contact name and telephone number (in case we have questions)
 - * A list of the defective item number and quantity with the nature/ reason of the defect
 - * Special instructions you have for us
 - * The enclosed fax form may be used for your convenience to request an RMA
3. UPI will review the request to ensure the products are within the stated warranty period.
4. Once we have validated the warranty items, a RMA confirmation, listing the items and cost will be faxed to the customer within 3 business days. UPI will process the credit to your account within 30 days.

Note: There will be no need to return the warranty product to us. However, from time to time, UPI may require some warranty products to be shipped back so we may analyze the cause of the failure. All warranty products that are required to be shipped back will be freight prepaid by UPI.

Stock Return

United Pacific Industries encourages all customers to regularly monitor the sales volume and stock level of their inventory items. As sales trends may slow the movement of specific items, our hope is that those items are featured as "close-out specials" as to minimize stock returns. We also understand that the customer, from time to time, may accumulate over-stock items and desire to return those. Therefore, we have adopted the following policy below.

NOTE:

- * Items must have been purchased by the dealer requesting the stock return.
- * Items must have been purchased within the preceding 12 months.
- * Items that have been discontinued will not be considered for return.

1. Contact the United Pacific office for RMA number We have 2 acceptable methods for requesting the RMA:
 - By e-mail : returns@uapac.com
 - By fax : (888) 986-5988
 - ***Note: To ensure you receive a timely RMA credit, we cannot accept RMA requests by phone.**
2. You will be required to provide the following information:
 - * Your business name
 - * Contact name and telephone number (in case we have questions)
 - * A list of defective items: Item numbers and quantity of each
 - * Special instructions you have for us
3. Your claim will be reviewed within 5 business days and you will be contacted by your sales representative who will discuss solutions to liquidate these slow moving items.

Item #	Page #	Item #	Page #	Item #	Page #	Item #	Page #	Item #	Page #
10046	61	31163	52	32142	59	32685	15	33097	10
10247	45	31164	52	32143	23	32686	15	33098	10
10305	51	31187	47	32143	59	32687	15	34123	65
10313	50	31188	47	32144	23	32688	15	34124	65
10314	50	31203	33	32144	59	32689	15	34125	65
10722	56	31204	33	32186	32	32690	15	34404	25
20216	58	31205	34	32194	32	32691	15	34405	25
20217	58	31206	34	32508	48	32724	61	34406	25
20218	58	31222	48	32509	48	32725	61	34407	25
20219	58	31223	48	32509	50	32726	61	34408	25
20220	58	31223	50	32557	60	32727	61	34409	25
20221	58	31224	47	32558	60	32728	61	34410	25
20572	22	31225	47	32559	60	32729	61	34411	25
20584	22	31226	47	32590	53	32730	66	34412	25
20619	7	31227	47	32591	53	32731	66	34413	25
20620	8	31228	47	32592	53	32732	66	34414	25
20897	14	31229	47	32593	53	32733	66	34415	25
20898	14	31230	52	32648	44	32734	66	34416	25
21061	3	31231	52	32649	44	32735	66	34417	25
21062	3	31232	52	32650	5	32736	66	34418	25
21063	3	31233	52	32651	5	32737	66	34419	25
21064	3	31234	23	32652	5	32738	66	34420	25
21191	3	31237	74	32653	5	32739	66	34421	25
21200	3	31238	74	32654	5	32740	66	34422	25
21454	3	31239	52	32655	5	32741	66	34423	25
21456	3	31240	52	32656	5	32742	66	34424	25
21682	14	31243	73	32657	5	32743	66	34425	25
21683	14	31244	73	32658	5	32746	67	34426	25
21792	76	31245	73	32659	5	32747	67	34427	25
21793	76	31246	73	32660	5	32748	67	34428	26
21794	76	31247	35	32661	5	32749	67	34429	26
21795	76	31252	52	32662	5	32750	67	34430	26
21798	62	31253	52	32663	5	32751	67	34431	26
21798	72	31254	11	32664	16	32752	67	34432	26
21799	72	31255	11	32665	16	32753	67	34433	26
23016	71	31256	11	32666	16	32754	67	34434	26
23066	71	31257	11	32667	16	32755	67	34435	26
23197	49	31259	59	32668	16	32756	67	34436	26
23198	49	31267	23	32669	16	32757	67	34437	26
23525	31	31267	59	32670	16	32758	67	34438	27
23529	31	31279	44	32671	16	32759	67	34439	27
23578	39	31280	43	32672	16	33080	9	34440	27
23579	39	31281	43	32673	16	33081	9	34441	27
29095	55	31282	43	32674	16	33082	9	34442	27
30069	68	31293	60	32675	16	33083	9	34443	27
30104	69	31294	60	32676	16	33084	9	34444	27
30374	61	31463	42	32677	16	33085	9	34445	27
30707	9	31464	42	32678	15	33086	9	34446	28
30708	9	31497	16	32679	15	33087	10	34447	28
31139	43	31498	15	32680	15	33088	10	34448	28
31140	43	31517	41	32681	15	33089	10	34449	28
31141	43	31518	41	32682	15	33090	10	34450	28
31142	43	32018	5	32683	15	33091	9	34451	28
31143	44	32141	59	32684	15	33096	10	34452	28

Item #	Page #	Item #	Page #	Item #	Page #	Item #	Page #	Item #	Page #
34453	28	36545	21	36717	36	38005	74	70585	70
34454	28	36546	19	36757	27	40086	39	70586	70
34455	28	36546	21	36758	27	40982	72	70587	70
34456	28	36547	21	36759	27	41436	75	70588	70
34457	28	36549	19	36760	27	41442	57	70590	56
34458	29	36549	21	36761	25	41444	76	70598	49
34459	29	36550	19	36762	25	41695	35	70599	49
34460	29	36550	21	36763	17	41696	35	70607	70
34461	29	36617	65	36764	17	41738	49	70609	70
34462	68	36618	60	36765	17	41744	19	70632	70
34463	68	36619	74	36766	17	42214	2	70639	70
34464	68	36620	74	36767	17	42215	2	70651	20
34465	68	36632	44	36768	17	42216	2	70651	37
34466	68	36633	44	36769	21	42217	2	70651	38
34467	68	36634	12	36770	21	42218	2	70652	49
34468	68	36635	12	36779	2	42219	2	70653	46
34469	68	36636	12	36780	2	42222	56	70659	20
34470	68	36637	12	36781	1	42223	56	70659	39
34471	69	36638	12	36782	1	42318	72	70660	30
34472	69	36639	12	36783	1	42330	55	70661	30
34473	69	36640	12	36784	1	42330	62	70662	30
34474	69	36641	12	36785	1	42330	62	70663	30
34475	69	36642	12	36786	1	42333	62	70666	37
34476	69	36643	12	36832	64	42334	62	70666	38
34477	69	36644	12	36836	63	42335	62	70672	37
34478	69	36646	1	36837	63	42336	62	70672	38
34479	69	36647	1	36843	53	42372	62	70673	39
36411	54	36648	1	36844	53	42372	62	70674	56
36412	54	36649	1	36861	13	42779	55	70677	46
36413	54	36650	1	36862	13	45974	71	70679	46
36414	54	36651	1	36863	13	45993	71	70681	75
36415	54	36652	63	36864	13	46152	19	70683	20
36416	54	36653	63	36889	14	50014	4	70683	37
36417	54	36654	63	36890	14	50065	4	70683	38
36418	54	36655	63	36891	59	50065	40	70684	20
36419	54	36656	63	36892	59	50070	31	70684	39
36420	54	36657	63	36893	53	50075	40	70685	30
36421	54	36658	24	36894	53	50079	4	70686	30
36422	54	36659	24	36895	53	50082	31	70687	30
36423	54	36660	24	36896	53	50083	31	70688	30
36424	54	36661	24	36897	13	50084	31	70689	30
36425	54	36662	24	36898	13	50085	31	70690	49
36426	54	36663	24	36899	13	50107	31	70691	71
36533	48	36664	63	36900	13	50134	72	70692	37
36534	48	36665	63	36901	13	50135	72	70692	38
36535	48	36708	36	36902	13	50148	19	70693	37
36536	48	36709	36	36903	34	50149	19	70693	38
36536	50	36710	36	36904	34	50187	19	70694	39
36537	17	36711	36	36905	13	60048	45	70695	46
36538	17	36712	36	36906	13	60049	45	70696	46
36539	17	36713	36	36907	13	70025	30	70697	46
36540	17	36714	36	36908	13	70135	62	70699	75
36543	21	36715	36	38004	74	70136	62	70709	75
36545	19	36716	36	38005	60	70361	55	70710	75

Item #	Page #	Item #	Page #	Item #	Page #
72026	71	87997	6	36552B	54
72031	71	88142	29	36553B	54
86800	7	88234	2	36554B	54
86801	7	88235	2	36621B	45
86802	7	88236	2	36622B	45
86803	7	88238	64	36658B	24
86804	7	88248	35	36659B	24
86805	7	88249	35	36660B	24
86806	7	88250	35	36661B	24
86807	7	88261	76	36662B	24
86808	7	90627	10	36663B	24
86809	7	90628	10	36845B	24
86810	7	90800	18	36846B	24
86811	7	90801	18	36849B	13
86812	7	90802	18	36850B	13
86813	7	90803	18	38004B	74
86814	7	90804	18	38005B	60
86815	7	90805	18	38005B	74
86816	7	90806	18	42390B	4
86817	7	90807	18	42391B	4
86818	7	99007	76	70601B	71
86819	7	99083	6	S2007LED	40
86820	7	99084	6	S2007LED-A	40
86821	7	99085	6	S2007LED-W	40
86823	7	99086	6		
86824	7	99089	57		
86825	8	99090	57		
86826	8	110135	19		
86827	8	110136	19		
86828	8	110150	58		
86829	8	110169	31		
86830	8	110203	22		
86831	8	110203	40		
86832	8	110204	22		
86833	8	110204	40		
86834	8	110205	22		
86835	8	110205	40		
86836	8	110210	40		
86837	8	110211	40		
86838	8	110265	40		
86839	8	10000B	45		
86840	8	10007B	45		
86841	8	10046B	61		
86842	8	10281B	57		
86843	8	10351B	14		
86844	8	10722B	56		
86845	8	31346-L	75		
86846	8	31346-R	75		
86848	8	32171-13	32		
86849	8	32171-14	29		
87992	6	32171-14	32		
87993	6	32171-15	32		
87994	6	32192B	72		
87996	6	36551B	54		

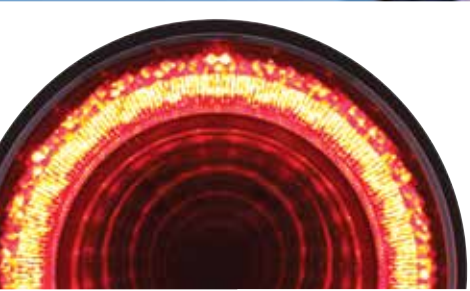

truck.uapac.com

3788 E. Conant St., Long Beach, CA 90808

F: 888.986.5988

T: 800.790.6988

E: sales@uapac.com

 Like us on Facebook: www.facebook.com/uapac.truck/

UF1216

2016 NEW ITEM FLYER COLLECTION



710270055791